

# ECMA

EUROPEAN COMPUTER MANUFACTURERS ASSOCIATION

---

STANDARD ECMA-110

– ERGONOMICS –  
REQUIREMENTS FOR  
MONOCHROMATIC VISUAL  
DISPLAY DEVICES

December 1985

Free copies of this document are available from ECMA,  
European Computer Manufacturers Association  
114 Rue du Rhône - 1204 Geneva (Switzerland)

# ECMA

EUROPEAN COMPUTER MANUFACTURERS ASSOCIATION

---

STANDARD ECMA-110

– ERGONOMICS –  
REQUIREMENTS FOR  
MONOCHROMATIC VISUAL  
DISPLAY DEVICES

December 1985

## BRIEF HISTORY

ECMA published in March 1985 Technical Report ECMA TR/22 which gives general ergonomic recommendations for VDU work places. These recommendations address not only the characteristics of the visual display terminal (VDT) but also other aspects such as the geometry of work places, arrangements, lighting, noise and ambient conditions. Most of these aspects, as well as the social, organizational and motivational characteristics of the office and business in general are under the control of the user, hence the issue of a Technical Report giving recommendations only.

The requirements for the display unit and the keyboard being entirely under the control of the manufacturers, it was decided to issue a standard specifying mandatory requirements. This Standard includes an Appendix specifying methods of measurement of the parameters specified with the exception of flicker and glare for the reasons indicated in Notes 1 and 2 of the Standard.

Further work is in progress on colour displays and non-CRT technology displays.



## TABLE OF CONTENTS

	<u>Page</u>
1. SCOPE	1
2. FIELD OF APPLICATION	1
3. CONFORMANCE	1
4. REFERENCES	1
5. DEFINITIONS	2
5.1 Luminous Intensity	2
5.2 Luminance	2
5.3 Luminous Flux	2
5.4 Illuminance	2
5.5 Reflectance	2
5.6 Luminosity	2
5.7 Glare	2
5.8 Contrast	2
5.8.1 Subjective sense	2
5.8.2 Objective sense	3
5.9 Resolution	3
5.10 Polarity of the Image Presentation	3
5.10.1 Negative polarity	3
5.10.2 Positive polarity	3
5.11 Legibility	3
5.12 Readability	3
5.13 Reflected Luminance	3
6. REQUIREMENTS FOR VDTs	3
6.1 Work Equipment	3
6.1.1 Characteristics of VDT-housing	3
6.1.2 Keyboard characteristics	5
6.2 Characteristics of Displayed Image	6
6.2.1 Higher luminance level	6
6.2.2 Lower luminance level	6
6.2.3 Flicker	7
6.2.4 Glare	7
6.2.5 Positive/Negative Polarity	7
6.2.6 Character presentation	7
APPENDIX A - METHODS OF MEASUREMENT	9

## 1. SCOPE

- 1.1 This ECMA Standard specifies requirements for Visual Display Terminals (VDT) using a monochromatic CRT and an associated keyboard input.
- 1.2 This Standard applies specifically to VDTs used intensively by a seated operator who is a skilled typist, for data entry work, data acquisition, interactive communication, or word processing.
- 1.3 The requirements of this Standard are restricted to those features of the display unit and keyboard which are entirely under the control of the manufacturer and, as such, are mandatory.
- 1.4 This Standard does not address those ergonomic considerations which are under the control of the user since these can be given only as recommendations. Recommendations for these considerations are to be found in ECMA TR/22.

## 2. FIELD OF APPLICATION

The subject of this Standard is those physical characteristics of monochrome CRT displays and their associated keyboards which ECMA feels are relevant to the comfort and well-being of the operator and are necessary to ensure an efficient interface between the operator and the work-station.

However, these characteristics alone are not sufficient to ensure an efficient interface, and, for those aspects of work station design which are exclusively under the user's control, the reader is referred to the Technical Report ECMA TR/22, which is complementary to this document.

## 3. CONFORMANCE

A VDT consisting of a monochromatic CRT display unit and its associated keyboard shall be in conformance with this Standard if all the requirements herein are met.

The VDT shall also comply with the requirements of Standard ECMA-57.

The VDT shall conform to the acoustic noise limits prescribed at its location of use. The sound power output of the VDT shall be measured according to Standard ECMA-74.

## 4. REFERENCES

- ECMA-57 : Safety Requirements for Data Processing Equipment
- ECMA-74 : Measurement of Airborne Noise Emitted by Computers and Business Equipment
- ECMA/TR22: Recommendations for VDU Work Places
- ECMA/TR33: Visual Displays - Health Aspects
- ISO 2813 : Paints and Varnishes - Measurements of specular gloss of non-metallic paint films at 20°, 60° and 85°

## 5. DEFINITIONS

For the purpose of this Standard, the following definitions apply:

### 5.1 Luminous Intensity

The candela (cd) is the luminous intensity in a given direction of a source which emits monochromatic radiation of frequency  $540.10^{12}$  Hz and of which the radiant intensity in that direction is 1/683 watt per steradian.

### 5.2 Luminance

The luminance, at a point of a surface and in a given direction, is the luminous intensity of an element of the surface divided by the area of the orthogonal projection of this element on a plane perpendicular to the given direction. The unit of luminance is the candela per square meter ( $\text{cd}/\text{m}^2$ ).

### 5.3 Luminous Flux

The luminous flux  $d\phi$  of a source of luminous intensity  $I$  in an element of solid angle  $d\Omega$  is  $d\phi = I d\Omega$ . The unit of luminous flux is the lumen ( $1\text{lm} = 1 \text{cd}\cdot\text{sr}$ ).

### 5.4 Illuminance

The illuminance at a point of a surface is the luminous flux incident on an element of the surface, divided by the area of that element. The unit of illuminance is the lux ( $1\text{lx} = 1\text{lm}/\text{m}^2$ ).

### 5.5 Reflectance

The ratio  $\rho$  of the luminous flux reflected from a surface to the luminous flux incident on it. Reflectance may be specular or diffuse.

### 5.6 Luminosity

Attribute of visual perception associated with the amount of light emitted from a given area. Luminosity is also known as "brightness".

### 5.7 Glare

The discomfort or impairment of vision experienced when parts of the visual field are excessively bright in relation to the brightness of the general surroundings.

### 5.8 Contrast

The difference between two compared stimuli. This term is used both in a subjective and an objective sense.

#### 5.8.1 Subjective sense

The difference in appearance of two parts of a field of view seen simultaneously or successively.



### 5.8.2 Objective sense

The difference in luminance levels between the viewed image and its background expressed as the contrast ratio:

$$c = \frac{L_o}{L_b}$$

where:

$L_o$  = object luminance

$L_b$  = background luminance.

### 5.9 Resolution

The number of dots per unit of length.

### 5.10 Polarity of the Image Presentation

#### 5.10.1 Negative polarity

Light or illuminated characters presented on a darker or unilluminated background.

#### 5.10.2 Positive polarity

Dark or unilluminated characters presented on a lighter or illuminated background.

### 5.11 Legibility

The quick and correct recognition of single symbols.

### 5.12 Readability

The human ability to interpret strings of characters into meaningful units (e.g. words, phrases, equations, etc.).

### 5.13 Reflected Luminance

The reflected luminance  $L$  is given by:

$$L = \frac{\rho \cdot E}{\pi}$$

where:

$L$  = reflected luminance in  $\text{cd/m}^2$

$\rho$  = surface reflectance

$E$  = ambient illuminance in  $\ell x$

## 6. REQUIREMENTS FOR VDTs

This Section specifies the mandatory requirements to be met by CRT-based VDTs and their keyboards the use of which is limited as specified in clause 1.

### 6.1 Work Equipment

#### 6.1.1 Characteristics of VDT-housing

##### 6.1.1.1 Adjustability

Keyboards of table-top units shall be separable from the screen, at least for a distance of 300 mm (Fig. 1).



The inclination of the surface of the screen shall be adjustable at least between  $-3^{\circ}$  and  $+15^{\circ}$  from the vertical (Fig. 2).

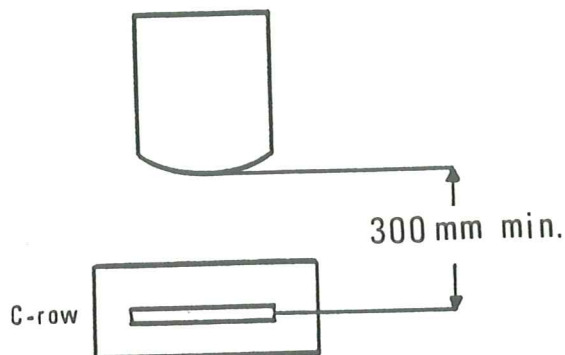

Fig. 1 - Separable Keyboard (seen from the top)

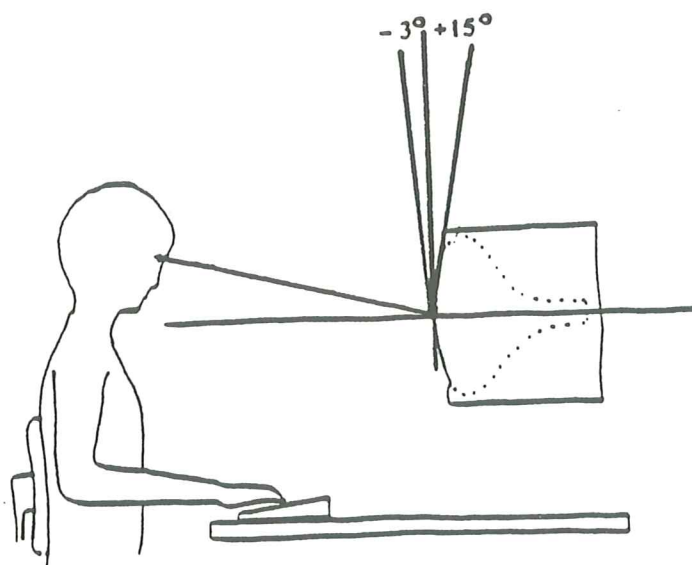

Fig. 2 - Tilt Angle

#### 6.1.1.2 Surfaces

The specular reflectance of surfaces shall not exceed 45 gloss units (silky matt).

The diffuse reflection factor for the front frame of the VDU screen shall be between 0,15 and 0,75. See A.3 and A.7.

## 6.1.2 Keyboard characteristics

### 6.1.2.1 Dimensions

The keyboard slope shall be in the range  $5^{\circ}$  to  $18^{\circ}$  (Fig. 3). Adjustability is not mandatory. See A.8.

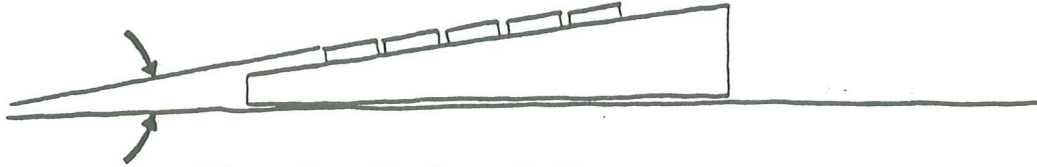

Fig. 3 - Keyboard Slope

A low profile keyboard shall not be higher than 35 mm measured from the work surface to the centre of a key-top at the C-row (Fig. 4 and 5) with the keyboard in its lowest position of angular adjustment.



Fig. 4 - Keyboard Rows

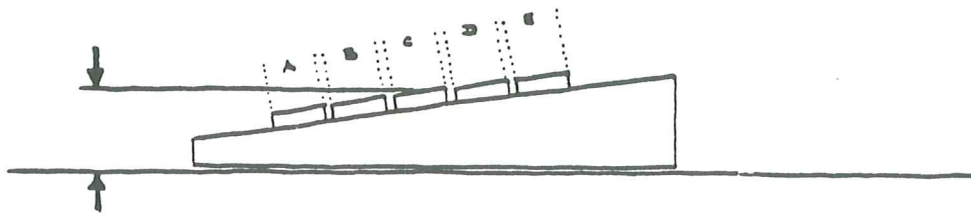

Fig. 5 - Keyboard Height

### 6.1.2.2 Geometry and layout of keytops

The key top (the portion of the key touched by the operator) shall be concave.

The area of the key top shall be at least  $113 \text{ mm}^2$ , the minimum dimension being 12 mm.

The horizontal distance between keys measured centre-to-centre shall be  $19 \text{ mm} \pm 1 \text{ mm}$  for the alphanumeric keys and separate numerical key pad, if provided.

### 6.1.2.3 Key characteristics

The keys shall have a travel between 1 mm and 8 mm.

The maximum key force shall be between 0,25 N and 1,50 N with a preferred force between 0,50 and 0,60 N. The force for alphanumeric keys shall be within  $\pm 25\%$  of the average force.

Feedback shall be provided in one of the following ways (or in any combination of them):

- a "stop" at some distance after electrical contact has been made,
- a "trigger" point in the depression movement past which the force ceases to increase,
- an audible click.

N key roll-over shall be provided, where  $N = 3$  or more. The N key roll-over should be consistent and applies to all alphanumeric keys.

The burst rate capability shall be at least 50 characters per second for at least 3 characters. During the burst the keys shall be recognized in the sequence of their action.

If the repeat rate of selected keys is fixed, then the repeat rate shall be  $(15 \pm 5)$  characters per second after at least 0,5 s. An adjustable repeat rate is preferred.

#### Surface

The surface of the keys and keyboard shall have the specular and diffuse reflectance values specified in 6.1.1.2. See A.3 and A.7.

Major symbols on the key tops shall have a contrast ratio of at least 3:1 with the surface of the key top and shall be at least 2,6 mm high.

## 6.2 Characteristics of Displayed Image

### 6.2.1 Higher luminance level

The higher luminance level shall be adjustable. The top limit of adjustment shall be at least  $45 \text{ cd/m}^2$  in a dark environment. The adjustment ratio shall be at least 2:1. See A.1.1.

### 6.2.2 Lower luminance level

The lower luminance level shall be such that the contrast ratio between higher and lower luminance is at least 3:1, at an ambient illuminance of 250 lux measured perpendicularly to the plane of the screen surface. See A.1.2, A.1.3 and A.2.



### 6.2.3 Flicker

Visual display units shall be designed so as not to flicker, i.e. any periodic light variation shall not be perceived.

#### NOTE 1

*This clause is part of the Standard because it is essential that VDUs should be flicker-free. However, for the time being no objective conformance test can be specified, as scientific investigations presently in progress have not allowed a reliable test method to be identified.*

### 6.2.4 Glare

Specular glare is a function of sharpness and maximum luminance of a reflected image. Specular glare should be minimized.

#### NOTE 2

*The design/manufacturing methods for reducing glare (if appropriate) include etched surfaces, optical coatings, micromesh filters, polarisers, hoods, etc. These methods are application-dependent and, as such, ECMA does not consider a conformance requirement to be appropriate for inclusion in this specification.*

*Attention is drawn to TR/22 clause 7.4 for user methods of reducing glare.*

### 6.2.5 Positive/Negative Polarity

Either polarity is acceptable.

### 6.2.6 Character presentation

#### 6.2.6.1 Character height/dot matrix

A character matrix consisting of 7 dots in the vertical direction and 5 dots in the horizontal direction shall be the minimum to be used for digits and capital letters.

The height shall be increased upward by two dot positions if diacritical marks are to be used. When displaying small letters, the height shall be increased downward by at least two dot positions to accommodate the descenders of the small letters. The minimum height of a capital letter shall be 2,9 mm regardless of screen size and dot matrix. See A.5.

#### 6.2.6.2 Character and stroke width proportions

The character width shall be between 50% and 80% of the character height. See A.5.

The stroke width shall be between 8% and 20% of the character height. See A.5.

#### 6.2.6.3 Spacing

The space between characters in both horizontal and vertical directions shall be equal to at least one dot. A character includes diacritical marks and descenders. See A.5.

#### 6.2.6.4 Distortion

##### 6.2.6.4.1 Luminance variation

For an intended uniform luminance, the variation in luminance from the centre to any part of the screen shall not exceed 50% of the luminance at the centre. See A.6.1.

##### 6.2.6.4.2 Screen geometric variation

Distortions of lines and columns shall be avoided. The perimeter line and column locations shall not vary by more than 2% of the respective total display width or height, respectively. See A.6.2.

##### 6.2.6.4.3 Character size variation

The height and width of a character shall not differ by more than 10% from the average height and width of all characters. This variation shall be measured for the five characters specified in A.6.3.

##### 6.2.6.4.4 Jitter

Location changes of a character in the frequency range between 0,1 and 30 Hz shall not be greater than 0,1 mm. See A.6.4.

APPENDIX A

METHODS OF MEASUREMENT

The methods of measurement specified in this Appendix shall be used for checking conformance to the clauses of this Standard. They are applicable to monochromatic CRT displays both with positive and negative polarity. Simplified methods have been specified with the aim of avoiding expensive and time-consuming measurements.

A.1 Luminance

The luminance of character and background (either with positive or negative polarity) shall be measured in terms of mean value (mean luminance).

A.1.1 Higher luminance level ( $L_h$ )

The higher luminance level represents, either the mean background luminance in case of positive polarity, or the mean character luminance in case of negative polarity.

The measurement of the higher luminance level  $L_h$  for the purpose of 6.2.1 shall be made in an unilluminated room, by means of a narrow-angle luminance probe. A full matrix (i.e. a cursor) of at least 5 x 5 dots shall be activated at the centre of the screen, as shown in Fig. A.1.

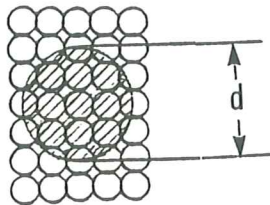

Fig. A.1

The diameter  $d$  of the circular area "seen" by the luminance probe shall be contained within the full matrix, but it shall completely cover a block of at least 3 x 3 dots. The maximum  $d$  shall be 10 mm. This is achievable by setting the proper distance from the probe to the surface of the screen, taking into account the visual angle of the probe itself.



In case of positive polarity, the result will be the background luminance  $L_b$ .

In case of negative polarity, the result will be assumed as the luminance of the character  $L_c$ .

#### A.1.2 Lower Luminance Level ( $L_{\ell a}$ )

The lower luminance level represents the character luminance in case of positive polarity, or the background luminance in case of negative polarity.

The measurement of the lower luminance level  $L_{\ell a}$  shall be made at the level of ambient illuminance on the screen specified in 6.2.2.

When measuring the lower luminance levels in presence of ambient illuminance, attention shall be paid:

- to avoid shading the measured area with the luminance probe,
- to avoid effects of specular reflection.

#### A.1.3 Contrast

Higher luminance levels for the purpose of calculating contrast ( $L_{ha}$ ) shall be measured in the presence of ambient illumination as in 6.2.2 using the narrow-angle luminance probe and with the ambient luminance head removed. The contrast ratio shall be:

$$\frac{L_{ha}}{L_{\ell a}}$$

#### A.2 Ambient Illuminance

The ambient illuminance on the screen shall be measured by means of a flat luxmeter head, applied to the surface itself, so as to reduce errors due to the thickness of the head.

The ambient illuminance shall be measured perpendicularly to the screen surface (see Fig. A.2).

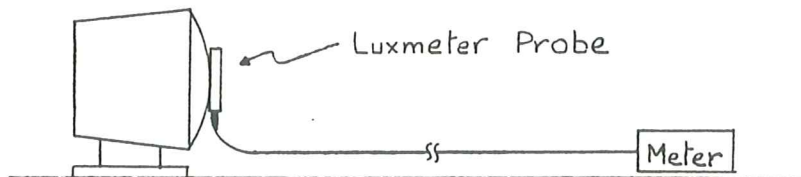

Fig. A.2

The present measurement applies to A.1.2. For this purpose, controlled illuminance shall be obtained by diffuse indirect lighting, avoiding specular reflections.

### A.3 Diffuse Reflection Factor

The diffuse reflection factor of opaque surfaces can easily be judged by means of a diffuse reflection factor chart.

This evaluation is applicable to 6.1.1.2 and 6.1.2.3.

#### NOTE A.1

Such charts are commercially available, for example from:

Verlag W. Girardet  
D-4300 ESSEN  
Germany

Part Number: 0725

From *Handbuch für Beleuchtung* (ISBN: 3-7736-0725-3)

### A.4 Flicker

See Note 1 in 6.2.3.

### A.5 Character Dimension

Character dimensions shall be measured from edge to edge and can vary with the luminance value. Therefore, the higher luminance level shall be set up at  $45 \text{ cd/m}^2$  or half the maximum value obtainable by the VDU, whichever is greater. The value is measured as indicated in A.1.1 except that this measurement is made at five character positions, namely at the centre of the screen and at the four extreme corners of the display area.

The edge shall be judged by the operator using a microscope with a graticule, a magnification power of typically 20 times and a field of view sufficient to cover the whole character.

The judgement or measurement shall be done in an unilluminated environment on capital letters H or E, and which involve all the external rows and columns of the net matrix.

Both in case of positive and negative polarity, the values are measured as shown in Fig. A.3.

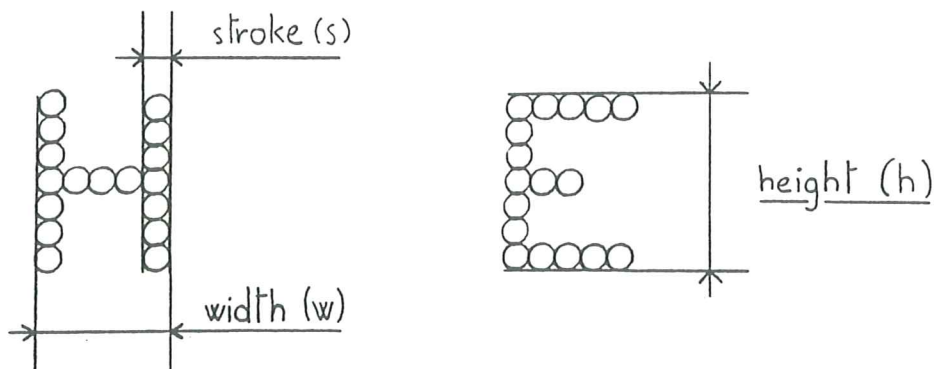

Fig. A.3

The present method applies to 6.2.6.1, 6.2.6.2, 6.2.6.3 and 6.2.6.4.2.

## A.6 Distortions

### A.6.1 Luminance Variation

The higher luminance level shall be measured according to A.1.1 on a full matrix (i.e. a block cursor) positioned at the centre and at the corners of the screen. The optical axis of the luminance probe shall be perpendicular to the screen surface at the points of measurement. The ratio:

$$\frac{L_h \text{ max}}{L_h \text{ min}}$$

shall comply with the values specified in 6.2.6.4.1.

### A.6.2 Screen Geometric

The geometric distortion of peripheral rows and columns may be judged by means of a transparent mask held against the screen and viewed in a direction parallel to the axis of the table. Dimensions and tolerances shall be in accordance with 6.2.6.4.2.

### A.6.3 Character Size Variation

The variations of the character dimensions shall be measured by placing a suitable capital letter (E or H) at the centre of the screen and in each of the extreme corner locations. The height and width of each of these characters shall be measured as described in A.5.

These measured heights and widths shall be compared with the averaged height  $\bar{h}$  and the averaged width  $\bar{w}$  calculated as follows.

$$\bar{h} = \frac{n}{N} \cdot H$$

$$\bar{w} = \frac{m}{M} \cdot W$$

where:

H : total height of the active area of the screen

W : total width of the active area of the screen

n : number of dot lines in the character

m : number of dot columns in the character

N : total number of dot lines in the active area

M : total number of dot columns in the active area



#### A.6.4 Character Stability

Changes of character position in any direction shall be measured in terms of dot movement, according to Fig. A.5 or Fig. A.6.

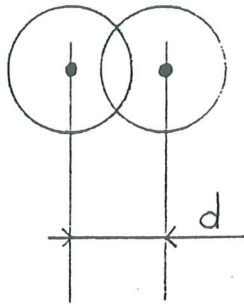

Between dot centres

Fig. A.5

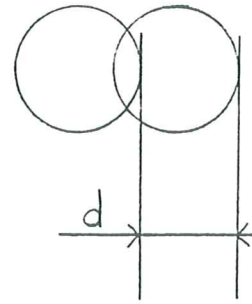

Between dot edges

Fig. A.6

The measurement shall be made by means of a microscope with a graticule and a magnification power of at least 20 times.

Character stability shall be measured at the centre and at the corners of the screen.

The jitter shall comply with the limits specified in 6.2.6.4.3.

#### A.7 Specular Reflectance

The specular reflectance of external surfaces, including keycaps and excluding CRT screen shall be measured by means of a 60° glossmeter calibrated against a Reference Glass Mirror, according to International Standard ISO 2813.

The surfaces meeting the characteristics (planarity and dimensions) needed for proper operation of the instrument chosen shall be measured directly. In the case of surfaces too small and/or too curved (e.g. keycaps) the measurement shall be performed on a sample surface of suitable planarity and dimensions but treated exactly as the surface under consideration.

#### A.8 Keyboard Slope

The slope of the keyboard shall be the angle between the horizontal plane and a line drawn through the centres of key rows B and D.

