Safety of electronic equipment

Standard ECMA-287

Technical Report EACEM TR-027

ECMA – Standardizing Information and Communication Systems

Phone: +41 22 849.60.00

Fax: +41 22 849.60.01

www.ecma.ch

helpdesk@ecma.ch

EACEM - European Association of Consumer Electronics Manufacturers

Phone: +32 2 644.26.81

Fax: +32 2 640.44.09

www.eacem.be

helpdesk@eacem.be

Safety of electronic equipment

Standard ECMA-287

Technical Report EACEM TR-027

ECMA – Standardizing Information and Communication Systems

Phone: +41 22 849.60.00

Fax: +41 22 849.60.01

www.ecma.ch

helpdesk@ecma.ch

EACEM - European Association of Consumer Electronics Manufacturers

Phone: +32 2 644.26.81

Fax: +32 2 640.44.09

www.eacem.be

helpdesk@eacem.be

Brief History

The advent of multimedia products has blurred the borderline between different classes of products, like IT equipment, audio-video equipment, communication equipment, and the environment within which the equipment is used.

Personal computers which used to be connected only to printers and occasionally modems are now frequently connected to loudspeakers, scanners, video and audio tape recorders, TV sets. The environment has changed from the office (or home office), to include all the rooms of the house, and, for portable equipment, outdoor leisure areas. The age of the user and of the bystander is continuously reducing.

This changing situation has generated a new set of conditions that are to be taken into account when designing new equipment.

For the above reasons ECMA TC12 decided to develop a generic standard for safety of electronic equipment, and established a close co-operation with EACEM WG4/PT4.2. ECMA provided secretariat facilities.

Included in the scope of the standard are IT equipment, audio and video equipment, and in general electronic equipment with a rated voltage not exceeding 600 V and intended for domestic or professional use and environment. The equipment may be an independent unit or a system of interconnected units.

The philosophy applied this new standard has been to define hazard-based requirements, using engineering principles and taking into account relevant IEC equipment standards and pilot documents. Where technical discrepancies between standards emerged, a conclusion was based on engineering principles.

In the body of this document, the term “standard” is used as a self-reference. When the document is used as an EACEM Technical Report, the reference is to be taken to mean “this EACEM Technical Report”.

This ECMA Standard has been adopted by the ECMA General Assembly of 24 June 1999

This EACEM Technical Report has been approved by EACEM on 15 June 1999

Table of contents

1	Guidance principles and basic information	1
1.1	Scope	1
1.2	Additional requirements	2
1.3	References	2
2	Definitions	4
2.1	Basic insulation	4
2.2	Class I	4
2.3	Class II	4
2.4	Clearance	4
2.5	Creepage distance	4
2.6	Disconnect device	4
2.7	Double insulation	4
2.8	Electrical enclosure	4
2.9	Enclosure	4
2.10	Extra-low voltage circuit (ELV circuit)	4
2.11	Fire enclosure	4
2.12	Functional insulation	4
2.13	Hazardous energy level	4
2.14	Hazardous live	5
2.15	Hazardous voltage	5
2.16	Intermittent operation	5
2.17	Limited current circuit	5
2.18	Mains	5
2.19	Mechanical enclosure	5
2.20	Non-detachable power supply cord	5
2.21	Normal operating condition	5
2.22	Permanently connected equipment	5
2.23	Pluggable equipment type A	5
2.24	Pluggable equipment type B	5
2.25	Pollution degree	5
2.26	Pollution degree 1	5
2.27	Pollution degree 2	6
2.28	Pollution degree 3	6
2.29	Potential ignition source	6
2.30	Primary circuit	6
2.31	Rated current	6
2.32	Rated frequency	6
2.33	Rated operating time	6
2.34	Rated voltage	6
2.35	Reinforced insulation	6
2.36	Required withstand voltage	6
2.37	Ripple-free	6

2.38	Safety extra-low voltage circuit (SELV circuit)	6
2.39	Safety interlock	7
2.40	Secondary circuit	7
2.41	Service access area	7
2.42	Service personnel	7
2.43	Short-time operation	7
2.44	Stationary equipment	7
2.45	Supplementary insulation	7
2.46	Telecommunication network	7
2.47	Temperature limiter	8
2.48	Thermal cut-out	8
2.49	Thermostat	8
2.50	TNV-1 circuit	8
2.51	TNV-2 circuit	8
2.52	TNV-3 circuit	8
2.53	Transportable equipment	8
2.54	Tool	8
2.55	Touch current	8
2.56	User access area	8
2.57	User	8
2.58	Working voltage	8
3	Electric shock hazards	9
3.1	Prevention of access to hazardous live parts	9
3.1.1	Test methodology	10
3.2	Providing a suitable insulation system	11
3.2.1	Clearances	11
3.2.2	Creepage distance	16
3.2.3	Solid insulation, general requirements	17
3.2.4	Coated Printed Circuit Boards	22
3.2.5	External terminations of components	25
3.2.6	Enclosed and sealed components	26
3.2.7	Spacings filled by insulating compound	26
3.2.8	Wound components without interleaved insulation	27
3.2.9	Bridging of double insulation or reinforced insulation	29
3.3	Reliable earthing	30
3.3.1	Resistance of protective earthing conductors.	30
3.3.2	Continuity of earthing path.	30
3.3.3	Reliable fixing of any connections	31
3.3.4	Corrosion resistance of protective earthing conductors	31
3.3.5	Integrity of protective earth path	31
3.4	Electrical enclosures	31
3.4.1	Test methodology	31
3.4.2	Compliance criteria	31
3.5	Safety interlock system	31
3.6	Design of adequate wiring	31

3.6.1	Wire routing of internal wiring	31
3.6.2	Wire connection	32
3.6.3	Power supply cords	32
3.7	Discharging of capacitors in primary circuits	33
3.7.1	Test methodology	33
3.7.2	Compliance criteria	33
3.8	Disconnect device	33
4	Mechanical hazards	34
4.1	Sharp edges and corners	34
4.2	Hazardous rotating or otherwise moving parts	34
4.3	Loosening, exploding or imploding parts	35
4.4	Instability of equipment	35
5	Fire hazards	37
5.1	Fire hazards under normal operating conditions	39
5.1.1	Requirements	39
5.1.2	Test methodology	39
5.2	Limit start and spread of fire under abnormal operating conditions	40
5.3	Simulation of abnormal operating conditions (Method 1)	40
5.3.1	Requirements	40
5.3.2	Test methodology	40
5.3.3	Compliance criteria	41
5.3.4	Use of protection devices to limit heating under abnormal operation	41
5.3.5	Separation from potential ignition sources	41
5.4	Reduce the spread of fire (Method 2)	42
5.4.1	Parts requiring a fire enclosure	42
5.4.2	Parts not requiring a fire enclosure	43
5.4.3	Materials for fire enclosure	43
5.4.4	Top and side openings in fire enclosures	44
5.4.5	Bottoms of fire enclosures	44
5.4.6	Doors or covers in fire enclosures	45
5.4.7	Materials for components and parts inside fire enclosure	45
5.5	Mains cord and mains wiring	46
5.5.1	Mains supply cords	46
5.5.2	Cord anchorages	47
5.5.3	Terminals for mains cord	48
5.5.4	Appliance inlet supplied with the equipment for connection of detachable power supply cord	48
5.6	Flammable liquids and vapours	48
5.7	Batteries	49
6	Burn Hazards	50
6.1	Requirements	50
6.2	Test Methodology	51
7	Chemical hazards	52

7.1	Hazardous chemicals	52
7.2	Ozone	53
7.3	Dust, particulates, liquids, or gases	53
8	Radiation	54
8.1	Laser radiation	54
8.2	Ionising radiation	54
Annex A	(informative) Examples of equipment within the scope of this Standard	57
Annex B	(normative) General conditions for tests	59
Annex C	(normative) Test probe	67
Annex D	(normative) Test generators	69
Annex E	(normative) Measuring network for touch currents	71
Annex F	(normative) Marking and instructions	73
Annex G	(normative) Components	79
Annex H	(normative) Transformers	83
Annex J	(normative) Motor tests under abnormal conditions	87
Annex K	(normative) Insulated winding wires for use without interleaved insulation	93
Annex L	(normative) Safety interlocks	95
Annex M	(normative) Disconnect devices	99
Annex N	(normative) Batteries	101
Annex P	(normative) Table of electrochemical potentials	103
Annex Q	(normative) Measurement of creepage distances and clearances	105
Annex R	(normative) Alternative method for determining minimum clearances	113
Annex S	(normative) Limiting the available current and energy	119
Annex T	(normative) Distance from potential ignition sources	121
Annex U	(normative) Tests for resistance to heat and fire	123
Annex V	(normative) Tests for enclosures	127
Annex W	(normative) Mechanical strength of CRTs and protection against the effects of implosion	129

1 Guidance principles and basic information

1.1 Scope

- **Applicability**

This standard is applicable to electronic equipment with a **RATED VOLTAGE** not exceeding 600 V rms and intended for domestic or professional use. The equipment may be powered from an a.c. or d.c. supply and can be an independent unit or a system of interconnected units.

The electronic equipment considered in this standard can be:

- office equipment;
- consumer electronic equipment;
- telecommunication terminal equipment;
- or a combination of the above.

NOTE

For a non-comprehensive list of equipment which is within the scope of this standard see annex A.

- **Protection**

The requirements of this standard are intended to provide protection to persons as well as to the surrounding of the equipment.

There are two types of persons who are normally concerned with electronic equipment, **USERS** and **SERVICE PERSONNEL**.

- “**USERS**” denotes any person who can be affected by the equipment, other than **SERVICE PERSONNEL**;
- “**SERVICE PERSONNEL**” denotes persons having appropriate technical training and experience necessary to be aware of hazards to which they may be exposed in performing a maintenance or repair task, and of measures to minimise the risks for themselves or other persons.

This standard specifies methods to provide protection to **USERS**, **SERVICE PERSONNEL** and to the surroundings. It is intended to be applied to all **USER ACCESS AREAS**. Where specific precautions are required for **SERVICE PERSONNEL**, these are given in the appropriate parts of the standard. Necessary warnings for **SERVICE PERSONNEL** may be provided in the service manual.

- **Hazards**

The application of this standard is intended to reduce the risk of injury and damage under **NORMAL OPERATING CONDITIONS** or abnormal operating conditions due to the following hazards:

- Electrical shock (clause 3)
- Mechanical (clause 4)
- Fire (clause 5)
- Burn (clause 6)
- Chemical (clause 7)
- Radiation (clause 8)

- **Users of the standard**

This standard is intended to be used by:

- designers of electronic equipment within the scope of the standard;
- safety validation engineers, either from the equipment manufacturers or from test houses.

The requirements and tests specified in this standard shall be applied only if safety is involved.

NOTE

In order to establish whether or not safety is involved, the circuits and construction shall be carefully investigated by means of fault tree analysis, failure modes and effect analysis, or similar techniques, to take into account the normal operating conditions and the consequences of possible failure of components.

This standard does not include requirements for performance or functional characteristics of equipment.

1.2 Additional requirements

Additional or more rigorous requirements than those specified in this standard, may be necessary for:

- equipment intended for operation while exposed, for example, to extremes of temperature; to excessive moisture, to vibration; to flammable gases; to corrosive or explosive atmospheres;
- equipment having an intrinsic safety function;

NOTE

Examples of this category of equipment include process controllers and air traffic controllers systems the failure of which may have a catastrophic effect.

- electromedical applications with physical connections to the patient;
- equipment intended to be used in vehicles, on board ships or aircraft, or at elevations greater than 2 000 m;
- equipment subject to transient over-voltages exceeding those for Installation Category II according to IEC 60664-1;
- equipment intended for use where ingress of water and dust is possible; for guidance on such requirements, and on relevant testing, see IEC 60529.

NOTE

Attention is drawn to the fact that authorities of some countries impose additional requirements.

1.3 References

The following standards contain provisions which, through reference in this text, constitute provisions of this standard. At the time of publication, the edition indicated was valid. All standards are subjected to revision, and parties to agreements based on this standard are encouraged to investigate the possibility of applying the most recent edition of the standards listed below.

ECMA

ECMA TR/56 (1991) Information Technology Equipment - Recommended Measuring Method for Ozone Emission

IEC

IEC 60027 series	Letter symbols to be used in electrical technology
IEC 60052 (1960-01)	Recommendations for voltage measurement by means of sphere-gaps (one sphere earthed)
IEC 60060 series	High-voltage test techniques
IEC 60068 series	Environmental testing
IEC 60085 (1984-01)	Thermal evaluation and classification of electrical insulation
IEC 60112 (1979-01)	Method for determining the comparative and the proof tracking indices of solid insulating materials under moist conditions
IEC 60127 series	Miniature fuses
IEC 60216 series	Guide for the determination of thermal endurance properties of electrical insulating materials.
IEC 60227 series	Polyvinyl chloride insulated cables of rated voltages up to and including 450/750 V
IEC 60245 series	Rubber insulated cables - Rated voltages up to and including 450/750 V
IEC 60309 series	Plugs, socket-outlets and couplers for industrial purposes
IEC 60320 series	Appliance couplers for household and similar general purposes
IEC 60364 series	Electrical installations of buildings
IEC 60384 series	Fixed capacitors for use in electronic equipment
IEC 60417 series	Graphical symbols for use on equipment
IEC 60454 series	Specifications for pressure-sensitive adhesive tapes for electrical purposes
IEC 60529 (1989-11)	Degrees of protection provided by enclosures (IP Code)
IEC 60664 series	Insulation co-ordination for equipment within low-voltage systems
IEC 60691 (1993-03)	Thermal-links - Requirements and application guide

IEC 60695 series	Fire hazard testing
IEC 60707 (1999-03)	Flammability of solid non-metallic materials when exposed to flame sources - List of test methods
IEC 60730 series	Automatic electrical controls for household and similar use
IEC 60738 series	Thermistors - Directly heated positive step-function temperature coefficient
IEC 60825 series	Safety of laser products
IEC 60851 series	Methods of test for winding wires
IEC 60950 (1999-04)	Safety of information technology equipment
IEC 60990 (1990-06)	Methods of measurement of touch-current and protective conductor current
IEC 61032 (1997-12)	Protection of persons and equipment by enclosures - Probes for verification
IEC 61058 series	Switches for appliances
IEC 61201 (1992-09)	Extra-low voltage (ELV) - Limit values
IEC Guide 105	Safety of equipment electrically connected to a telecommunication network

ISO

ISO 261:1998	ISO general-purpose metric screw threads -- General plan
ISO 262:1998	ISO general-purpose metric screw threads -- Selected sizes for screws, bolts and nuts
ISO 306:1994	Plastics -- Thermoplastic materials -- Determination of Vicat softening temperature (VST)
ISO 1043 series	Plastics -- Symbols and abbreviated terms
ISO 3864:1984	Safety colours and safety signs
ISO 4046:1978	Paper, board, pulp and related terms -- Vocabulary
ISO 7000:1989	Graphical symbols for use on equipment -- Index and synopsis
ISO 9772:1994	Cellular plastics - Determination of horizontal burning characteristics of small specimens subjected to a small flame
ISO 9773:1998	Plastics - Determination of burning behaviour of flexible vertical specimens in contact with a small-flame ignition source

2 Definitions

2.1 Basic insulation

Insulation to provide basic protection against electric shock.

2.2 Class I

Protection against electric shock achieved by:

- using **BASIC INSULATION**, and
- providing a means of connecting to the protective earthing conductor in the building wiring those conductive parts that are otherwise capable of assuming **HAZARDOUS VOLTAGES** if the **BASIC INSULATION** fails.

2.3 Class II

Protection against electric shock not relying on **BASIC INSULATION** only, but on additional safety precautions, such as **DOUBLE INSULATION** or **REINFORCED INSULATION**, without provision for protective earthing or reliance upon installation conditions.

2.4 Clearance

The shortest distance in air between two conductive parts.

2.5 Creepage distance

The shortest distance along the surface of an insulating material between two conductive parts.

2.6 Disconnect device

A means to physically disconnect equipment from the **MAINS**.

2.7 Double insulation

Insulation comprising both **BASIC INSULATION** and **SUPPLEMENTARY INSULATION**.

2.8 Electrical enclosure

An enclosure intended to minimise the accessibility of **HAZARDOUS LIVE** parts.

2.9 Enclosure

A part of the equipment providing one or more of the functions of **ELECTRICAL ENCLOSURE**, **FIRE ENCLOSURE** or **MECHANICAL ENCLOSURE**.

2.10 Extra-low voltage circuit (ELV circuit)

A **SECONDARY CIRCUIT** with voltages between conductors, and between any conductor and earth, not exceeding 42,4 V peak, or 60 V d.c., under **NORMAL OPERATING CONDITIONS**, which is separated from **HAZARDOUS VOLTAGE** by at least **BASIC INSULATION**, and which neither meets all of the requirements for an **SELV CIRCUIT** nor meets all of the requirements for a **LIMITED CURRENT CIRCUIT**.

2.11 Fire enclosure

An enclosure intended to minimise the spread of fire from within.

2.12 Functional insulation

Insulation needed only for the functioning of the equipment. **BASIC INSULATION** may also perform as **FUNCTIONAL INSULATION**.

NOTE

FUNCTIONAL INSULATION by definition does not protect against electric shock. It may however reduce the likelihood of ignition and fire

2.13 Hazardous energy level

A stored energy level of 20 J or more, or an available continuous power level of 240 VA or more at a potential of 2 V or more.

2.14 Hazardous live

Electrical condition of an object which can give a harmful electric shock.

NOTE

See 3.1.1.

2.15 Hazardous voltage

A potential exceeding the criteria for ELV and exceeding the criteria for limited current.

2.16 Intermittent operation

Operation in a series of specified cycles each composed of a period of operation under **NORMAL OPERATING CONDITIONS**, followed by a rest period with the equipment switched off or running idle.

2.17 Limited current circuit

A circuit which is so designed and protected that under both **NORMAL OPERATING CONDITIONS** and a likely fault condition the current which can be drawn is not hazardous.

2.18 Mains

The external power distribution system supplying operating power to the equipment.

MAINS is commonly considered the a.c. supply, but the word may also be used to identify a d.c. supply in which case it is the d.c. **MAINS**.

MAINS include public or private utilities and, unless otherwise specified in the standard, equivalent sources such as motor-driven generators and uninterruptible power supplies.

2.19 Mechanical enclosure

Enclosure intended to reduce the risk of injury due to hazards other than burn, fire and electric shock.

2.20 Non-detachable power supply cord

A flexible cord fixed to or assembled with the equipment.

2.21 Normal operating condition

Operating conditions as specified by the manufacturer. In the absence of specification the most unfavourable default values are used.

NOTE

See annex B.4 and B.7.

2.22 Permanently connected equipment

Equipment which can only be disconnected from the **MAINS** by the use of a **TOOL**.

2.23 Pluggable equipment type A

Equipment which is intended for connection to the **MAINS** via a non-industrial plug and socket-outlet or via an appliance coupler, or both.

2.24 Pluggable equipment type B

Equipment which is intended for connection to the **MAINS** via an industrial plug and socket-outlet complying with IEC 60309, or with national standards for similar applications.

2.25 Pollution degree

A numeral characterising the expected pollution of the micro-environment

2.26 Pollution degree 1

No pollution or only dry, non-conductive pollution occurs. The pollution has no influence on **CLEARANCES** or **CREEPAGE DISTANCES**.

NOTE

POLLUTION DEGREE 1 applies to components and assemblies which are sealed so as to exclude dust and moisture.

2.27 **Pollution degree 2**

Only non-conductive pollution occurs, except that occasionally a temporary conductivity caused by condensation is to be expected.

NOTE

POLLUTION DEGREE 2 applies generally for equipment covered by the scope of this standard.

2.28 **Pollution degree 3**

Conductive pollution occurs or dry non-conductive pollution occurs which becomes conductive due to expected condensation.

2.29 **Potential ignition source**

A possible fault such as a faulty contact or interruption in an electrical connection including conductors on printed boards, which can start a fire if, under **NORMAL OPERATING CONDITIONS**, the available power exceeds 15 W and the open circuit voltage exceeds 50 V (peak) a.c. or d.c.

2.30 **Primary circuit**

An internal circuit which is directly connected to the **MAINS**. It includes the primary windings of transformers, motors, other loading devices and the means of connection to the **MAINS**.

2.31 **Rated current**

The input current of the equipment as declared by the manufacturer and defined at **NORMAL OPERATING CONDITIONS**.

2.32 **Rated frequency**

The a.c. **MAINS** frequency or frequency range as declared by the manufacturer.

2.33 **Rated operating time**

The operating time assigned to the equipment by the manufacturer.

2.34 **Rated voltage**

The **MAINS** voltage (for three-phase supply, the phase-to-phase voltage) or voltage range as declared by the manufacturer.

2.35 **Reinforced insulation**

A single insulation system which provides a degree of protection against electric shock equivalent to **DOUBLE INSULATION**.

NOTE

*The term "insulation system" does not imply that the insulation has to be in one homogeneous piece. It may comprise several layers which cannot be tested as **SUPPLEMENTARY INSULATION** or **BASIC INSULATION**.*

2.36 **Required withstand voltage**

The peak voltage that the insulation under consideration is required to withstand.

2.37 **Ripple-free**

A d.c. voltage with an r.m.s. value of a ripple content of not more than 10% of the d.c. component.

2.38 **Safety extra-low voltage circuit (SELV circuit)**

A **SECONDARY CIRCUIT** which is so designed and protected that under normal and single fault conditions the voltage between any two parts of the **SELV CIRCUIT** or circuits, and, for **CLASS I** equipment, between any one such part and the equipment protective earthing terminal, does not exceed a safe value.

NOTE 1

Under normal conditions this limit is either 42,4 V a.c. peak, or 60 V d.c. Under fault conditions higher limits are specified in this standard for transient deviation.

NOTE 2

*This definition of **SELV CIRCUIT** differs from the term SELV as used in IEC 60364.*

2.39 Safety interlock

A means either preventing access to a hazardous area until the hazard is removed, or automatically removing the hazardous condition when access is gained.

2.40 Secondary circuit

A circuit which has no direct connection to primary power and derives its power from a transformer, converter or equivalent isolation device situated within the equipment.

2.41 Service access area

An area to which access can only be gained by using a **TOOL** or where access has been restricted to **SERVICE PERSONNEL** only according to the manufacturer instructions.

2.42 Service personnel

Persons having appropriate technical training and experience necessary to be aware of hazards to which they may be exposed in performing a repair or maintenance task, and of measures to minimise the risks for themselves or other persons.

2.43 Short-time operation

Operation under **NORMAL OPERATING CONDITIONS** for a specified period, starting from cold, the intervals after each period of operation being sufficient to allow the equipment to cool down to room temperature.

2.44 Stationary equipment

Equipment that is not **TRANSPORTABLE EQUIPMENT**.

2.45 Supplementary insulation

Independent insulation applied in addition to **BASIC INSULATION** in order to reduce the risk of electric shock in the event of a failure of the **BASIC INSULATION**.

2.46 Telecommunication network

A metallically terminated transmission medium intended for communication between equipment that may be located in separate buildings, excluding:

- the a.c. **MAINS** systems for supply, transmission and distribution of electrical power, if used as a telecommunication transmission medium;
- television distribution systems using cable.

NOTE 1

The term **TELECOMMUNICATION NETWORK** is defined in terms of its functionality, not its electrical characteristics. A **TELECOMMUNICATION NETWORK** is not itself defined as being a TNV circuit. Only the circuits in equipment are so classified.

NOTE 2

A **TELECOMMUNICATION NETWORK** may be

- publicly or privately owned;
- subject to transient overvoltages due to atmospheric discharges and faults in power distribution systems;
- subject to permanent longitudinal (common mode) voltages induced from nearby power lines or electric traction lines.

NOTE 3

Examples of **TELECOMMUNICATION NETWORKS** are

- a public switched telephone network;
- a public data network;
- an ISDN network;
- a private network with electrical interface characteristics similar to the above.

2.47 Temperature limiter

A temperature-sensing control which is intended to keep a temperature below or above one particular value during **NORMAL OPERATING CONDITIONS** and which may have provision for setting by the **USER**.

NOTE

A **TEMPERATURE LIMITER** may be of the automatic reset or of the manual reset type.

2.48 Thermal cut-out

A temperature-sensing control intended to operate under abnormal operating conditions and which has no provision for the **USER** to change the temperature setting.

NOTE

A **THERMAL CUT-OUT** may be of the automatic reset or of the manual reset type.

2.49 Thermostat

A cycling temperature-sensing control, which is intended to keep a temperature between two particular values under **NORMAL OPERATING CONDITIONS** and which may have provision for setting by the **USER**.

2.50 TNV-1 circuit

A TNV circuit:

- whose normal operating voltages do not exceed the limits for an **SELV CIRCUIT** under **NORMAL OPERATING CONDITIONS**; and
- on which over-voltages from **TELECOMMUNICATION NETWORKS** are possible.

2.51 TNV-2 circuit

A TNV circuit:

- whose normal operating voltages exceed the limits for an **SELV CIRCUIT** under **NORMAL OPERATING CONDITIONS**; and
- which is not subject to over-voltages from **TELECOMMUNICATION NETWORKS**.

2.52 TNV-3 circuit

A TNV circuit:

- whose normal operating voltages exceed the limits for an **SELV CIRCUIT** under **NORMAL OPERATING CONDITIONS**; and
- on which over-voltages from **TELECOMMUNICATION NETWORKS** are possible.

2.53 Transportable equipment

Equipment that is intended to be routinely carried by a **USER**.

NOTE

Examples include laptop personal computers, pen-based tablet computers, CD readers and portable accessories such as printers and CD-ROM drives.

2.54 Tool

A screwdriver or any other object which can be used to operate a screw, latch or similar fixing means.

2.55 Touch current

Electric current through a human body when it touches two or more accessible parts or one accessible part and earth.

2.56 User access area

An area to which, under **NORMAL OPERATING CONDITIONS**, one of the following applies:

- access can be gained, by using the test probe B of IEC 61032, without the use of a **TOOL**, or
- the means of access is deliberately provided to the **USER**, or
- the **USER** is instructed to enter regardless of whether or not **TOOLS** are needed to gain access.

2.57 User

Any person who can be affected by the equipment, other than **SERVICE PERSONNEL**.

2.58 Working voltage

The highest voltage to which the insulation or the component under consideration is, or can be, subjected when the equipment is operating under **NORMAL OPERATING CONDITIONS**.

3 Electric shock hazards

Electric shock is due to current passing through the human body. Currents in the order of a milli-ampere can cause a reaction in persons in good health and may cause indirect danger due to involuntary reaction. Higher currents can have more damaging effects. Voltages not exceeding 42,4 V peak, or 60 V d.c, are not generally regarded as dangerous under dry conditions and limited area of contact.

NOTE 1

The voltage limits are derived from IEC 61201 for dry conditions and grippable contact smaller than 80 cm².

NOTE 2

The requirements for connection to TELECOMMUNICATION NETWORKS are under consideration. Until this work is completed, the relevant requirements of IEC 60950:1999 are to be used.

Two levels of protection for USERS are needed to reduce the risk of electric shock, thus a single fault should not create a hazard. However, provision of additional protective measures, such as protective earthing or SUPPLEMENTARY INSULATION is not considered a substitute for, or relief from, properly designed BASIC INSULATION.

For the purposes of this standard, the risk of electric shock is considered to exist when accessible conductive parts become HAZARDOUS LIVE. Within this clause HAZARDOUS LIVE parts include contacts of HAZARDOUS LIVE terminals.

Conductive liquids used in the equipment shall be treated as conductive parts.

The equipment shall be so constructed that the risk of contact with HAZARDOUS LIVE parts under NORMAL OPERATING CONDITIONS or abnormal operating conditions is minimised.

The following table provides a list of prevention and protection methods in order to minimise risk of electric shock hazard.

Table 3.1 - Electric shock hazards

Cause of hazard	Clause	Prevention/protection methods
Access to HAZARDOUS LIVE parts	3.1	• Prevention of access to HAZARDOUS LIVE parts
	3.2	• Providing a suitable insulation system
	3.3	• Reliable earthing
	3.4	• ELECTRICAL ENCLOSURES
	3.5	• SAFETY INTERLOCK systems
	3.6	• Design of adequate wiring
	3.7	• Discharging of capacitors in PRIMARY CIRCUITS
	3.8	• DISCONNECT DEVICES

3.1 Prevention of access to hazardous live parts

The HAZARDOUS LIVE parts and parts which under abnormal operating condition become HAZARDOUS LIVE shall not be accessible, with the following exception:

Contacts of signal output terminals, if they have to be HAZARDOUS LIVE for functional reasons, provided the contacts are separated from the PRIMARY CIRCUIT:

- for CLASS I equipment by BASIC INSULATION,
- for CLASS II equipment by DOUBLE INSULATION or REINFORCED INSULATION.

NOTE

For the marking of such output terminals see F.2.1.3 d.

The risk of inadvertent contact of **HAZARDOUS LIVE** parts by **SERVICE PERSONNEL** shall be minimised by means such as guards or by warnings in the service manual.

The requirements of this clause apply to all positions of the equipment with **USER** detachable parts, including fuse holders, removed and with **USER** access doors and covers open.

These requirements can be fulfilled by one or more of the following:

- insulation system;
- **ELECTRICAL ENCLOSURES**;
- **SAFETY INTERLOCKS**.

3.1.1 Test methodology

Compliance is checked by inspection and measurement according to 3.1.1.1 and by tests according to 3.1.1.2.

3.1.1.1 Determination of hazardous live parts

In order to verify that a part or a contact of a terminal is **HAZARDOUS LIVE**, the following measurements are carried out between any two parts or contacts, then between any part or contact and either pole of the supply source used during the test.

The part or contact of a terminal is **HAZARDOUS LIVE** if:

- a) the open circuit voltage exceeds 42,4 V a.c. peak or 60 V d.c. and the **TOUCH CURRENT** exceeds the values given in table 3.2; or
- b) the discharge does exceeds 45 μC for stored charges at voltages between 70 V and 15 kV; or
- c) the energy of discharge exceeds 350 mJ for stored charges at voltages exceeding 15kV.

The measurement of the **TOUCH CURRENT** shall be carried out in accordance with IEC 60990 with the measuring network described in annex E. In addition, for **CLASS I** equipment the protective earthing shall be disconnected.

Table 3.2 - Maximum touch currents

Type of equipment	Maximum touch current normal operating condition	Maximum touch current abnormal operating condition
CLASS II equipment	0,5 mA r.m.s.	1,0 mA r.m.s.
CLASS I equipment; hand-held	0,5 mA r.m.s.	0,75 mA r.m.s.
CLASS I equipment; other	0,5 mA r.m.s.	3,5 mA r.m.s.

For **PERMANENTLY CONNECTED EQUIPMENT** and **PLUGGABLE EQUIPMENT TYPE B**, the maximum protective conductor current shall not exceed 5 % of the input current per line under **NORMAL OPERATING CONDITIONS**.

NOTE 1

It is recommended that for equipment intended to be used in tropical climates, the values given in a) and table 3.2, be halved.

NOTE 2

*To avoid unnecessarily high **TOUCH CURRENTS** when several equipments are interconnected, it is recommended that the individual **TOUCH CURRENT** values are not higher than needed for functional reasons.*

Discharges shall be measured to the terminal provided for connecting the apparatus to the supply source, immediately after the interruption of the supply.

3.1.1.2 Determination of accessibility

In order to verify that a part is accessible the jointed test finger and pin, see test probe B and test probe 13 of IEC 61032 respectively, are applied without appreciable force, in any possible position. Equipment preventing the entry of the jointed test finger are further tested by means of a straight

unjointed version of the test finger applied with a force of 30 N. If the unjointed test finger enters the equipment, the application of the jointed test finger is repeated, the finger being pushed through the aperture.

The test is repeated using the small finger probes 18 and 19 of IEC 61032. This does not apply if the intended conditions of use prevent the equipment from being accessed by children.

Openings in the top of enclosures are checked with the metal test pin of C.1. The test pin is suspended freely from one end and the penetration is limited to the length of the test pin.

Floor standing equipment having a mass exceeding 40 kg is not tilted during the test.

3.2 Providing a suitable insulation system

Accessible conductive parts shall be adequately isolated from **HAZARDOUS LIVE** parts.

Insulation shall be considered to be **BASIC INSULATION**, **SUPPLEMENTARY INSULATION**, **REINFORCED INSULATION** or **DOUBLE INSULATION**.

For **DOUBLE INSULATION** it is permitted to interchange the **BASIC INSULATION** and **SUPPLEMENTARY INSULATION** elements. Where **DOUBLE INSULATION** is used, **ELV CIRCUITS** or unearthed conductive parts are permitted between the **BASIC INSULATION** and the **SUPPLEMENTARY INSULATION** provided that the overall level of insulation is maintained.

Electrical isolation shall be achieved by provision of one or more of the following:

- **CLEARANCES** according to 3.2.1;
- **CREEPAGE DISTANCE** between parts and where applicable over their surfaces according to 3.2.2;
- solid insulating materials according to 3.2.3.

The choice and application of insulating materials shall take into account the needs for electrical, thermal and mechanical strength. Furthermore, the temperature, pressure and humidity of the environment and the pollution caused by the environment shall be taken into account.

3.2.1 Clearances

To limit current flow through air from circuits subject to transient overvoltages and peak voltages which may be generated within the equipment **CLEARANCES** in circuits and between circuits and accessible conductive parts shall be in accordance with the values as specified in table 3.4, taking into consideration the insulation in terms of **BASIC INSULATION**, **SUPPLEMENTARY INSULATION** or **REINFORCED INSULATION** and **WORKING VOLTAGE** and the relevant conditions specified under the table.

CLEARANCES, smaller than those determined from table 3.4, are allowed but are subjected to a short-circuit of the **CLEARANCE** during which accessible parts shall not become **HAZARDOUS LIVE**.

The determined **CLEARANCES** are not applicable to the air gap between the contacts of **THERMOSTATS**, **THERMAL CUT-OUTS**, overload protection devices, switches of microgap construction, and similar components where the **CLEARANCE** varies with the contacts.

3.2.1.1 Test methodology

Compliance is checked by measurement and, where applicable, by the following test.

The **CLEARANCE** shall be measured taking into account annex Q. The following conditions apply:

- Movable parts are placed in their most unfavorable positions.
- When measuring **CLEARANCES** from an **ENCLOSURE** of insulating material through a slot or opening in the **ENCLOSURE**, the accessible surface is considered to be conductive as if it were covered by metal foil wherever it can be touched by the test probe B of IEC 61032, applied without appreciable force. (See figure Q.14, point B)
- When measuring **CLEARANCES**, the 250 N force test has to be applied as follows:

External **ENCLOSURES** as fitted to the equipment are subjected to a steady force of $250\text{ N} \pm 10\text{ N}$ for a period of 5 s applied by means of a suitable test tool providing contact over a circular plane surface 30 mm in diameter. This test does not apply to **ENCLOSURES** of **TRANSPORTABLE EQUIPMENT** and of equipment intended to be held in the hand when operating.

The minimum required **CLEARANCE** shall be determined according to the following procedure. As an alternative the method of annex G may be used.

NOTE

*The minimum **CLEARANCES** for **BASIC INSULATION**, **SUPPLEMENTARY INSULATION** and **REINFORCED INSULATION**, whether in a **PRIMARY CIRCUIT** or another circuit, depend on the **REQUIRED WITHSTAND VOLTAGE**. The **REQUIRED WITHSTAND VOLTAGE** depends in turn on the combined effect of the **WORKING VOLTAGE** (including repetitive peaks due to internal circuitry such as switch mode power supplies) and non-repetitive overvoltages due to external transients.*

To determine the minimum value for each required **CLEARANCE**, the following steps shall be used:

1. Measure the peak **WORKING VOLTAGE** across the **CLEARANCE** in question. Pulses with a width below 1 μ s can be disregarded.
2. If the equipment is **MAINS** operated:
 - determine the **MAINS** transient voltage (3.2.1.1.1); and
 - note the peak value of the nominal a.c. **MAINS** voltage.
3. Use 3.2.1.1.3 and the above voltage values to determine the **REQUIRED WITHSTAND VOLTAGE** for a.c. **MAINS** transients and internal transients. In the absence of transients coming from **TELECOMMUNICATION NETWORKS**, go to step 7.
4. If the equipment is to be connected to **TELECOMMUNICATION NETWORKS**, determine the transients (3.2.1.1.2).
5. Use 3.2.1.1.3 and the above voltage values to determine the **REQUIRED WITHSTAND VOLTAGE** for transients coming from **TELECOMMUNICATION NETWORKS**.
6. The resulting **REQUIRED WITHSTAND VOLTAGE** is the larger of the value determined in step 3 and step 5.
7. Use the **REQUIRED WITHSTAND VOLTAGE** to determine the minimum **CLEARANCE** (3.2.1.1.4).

3.2.1.1.1 Determination of mains transient voltage

For equipment to be supplied from the a.c. **MAINS**, the value of the **MAINS** transient voltage depends on the Overvoltage Category and the nominal value of the voltage. In general, **CLEARANCES** in equipment intended to be connected to the a.c. **MAINS** shall be designed for a **MAINS** transient voltage in Overvoltage Category II.

Equipment that is part of the building power installation, or that may be subject to transient overvoltages exceeding those for Overvoltage Category II, shall be designed for Overvoltage Category III or IV, unless additional protection is to be provided external to the equipment. In this case, the installation instructions shall state the need for such external protection.

The applicable value of the **MAINS** transient voltage shall be determined from the Overvoltage Category and the nominal a.c. **MAINS** voltage using table 3.3.

Table 3.3 - Mains transient voltages

Nominal a.c. mains voltage, line-to-neutral	Mains transient voltage			
	Overvoltage Category			
	I	II	III	IV
≤ 50 V r.m.s	330 V peak	500 V peak	800 V peak	1 500 V peak
≤ 100 V r.m.s	500 V peak	800 V peak	1 500 V peak	2 500 V peak
≤ 150 V r.m.s ¹⁾	800 V peak	1 500 V peak	2 500 V peak	4 000 V peak
≤ 300 V r.m.s ²⁾	1 500 V peak	2 500 V peak	4 000 V peak	6 000 V peak
≤ 600 V r.m.s ³⁾	2 500 V peak	4 000 V peak	6 000 V peak	8 000 V peak

¹⁾ Including 120/208 or 120/240 V
²⁾ Including 230/400 or 277/480 V
³⁾ Including 400/690 V
Overvoltage categories are defined in IEC 60664-1.

The following tests are conducted only where it is expected that the transient voltages across the insulation in any circuit are lower than normal, due for example, to the effect of a filter in the equipment. The transient voltage across the insulation is measured using the following test procedure.

During the tests, the equipment is connected to its separate power supply unit, if any, but is not connected to the **MAINS** and any surge suppressors in **PRIMARY CIRCUITS** are disconnected.

A voltage measuring device is connected across the **CLEARANCE** in question.

The reduced level of transients is measured using the impulse test generator reference 2 of table D.1 with U_c equal to the **MAINS** transient voltage determined in 3.2.1.1.1.

Three to six impulses of alternating polarity, with intervals of at least 1 s between impulses, are applied between each of the following points where relevant:

- line-to-line;
- all line conductors conductively joined together and neutral;
- all line conductors conductively joined together and protective earth;
- neutral and protective earth.

Only one of a set of identical circuits is tested.

3.2.1.1.2 Determination of transients from telecommunications networks

If the **TELECOMMUNICATION NETWORK** transient voltage is not known for the **TELECOMMUNICATION NETWORK** in question, it shall be taken as:

- 1500 V peak if the circuit connected to the **TELECOMMUNICATION NETWORK** is a **TNV-1 CIRCUIT** or a **TNV-3 CIRCUIT**; and
- 800 V peak if the circuit connected to the **TELECOMMUNICATION NETWORK** is an **SELV CIRCUIT** or a **TNV-2 CIRCUIT**.

If it is expected that the transient voltages across the insulation in any circuit are lower than normal, the transient voltages are measured as follows.

A voltage measuring device is connected across the **CLEARANCE** in question.

To measure the reduced level of transients due to **TELECOMMUNICATION NETWORK** overvoltages, the impulse test generator reference 1 of table D.1 is used with U_c equal to the **TELECOMMUNICATION NETWORK** transient voltage determined in 3.2.1.1.2.

Three to six impulses of alternating polarity, with intervals of at least 1 s between impulses, are applied between each of the following connection points of a single interface type:

- two line connection points;

- all line conductors conductively joined together and protective earth.

Only one of a set of identical circuits is tested.

3.2.1.1.3 Determination of required withstand voltage

- **PRIMARY CIRCUIT** receiving the full **MAINS** transient:

For insulation in such a **PRIMARY CIRCUIT** the following rules shall be applied:

Rule 1) If the peak **WORKING VOLTAGE**, U_{pw} , is less than the peak value of the nominal a.c. **MAINS** voltage, the **REQUIRED WITHSTAND VOLTAGE** is the **MAINS** transient voltage determined in 3.2.1.1.1;

$$U_{\text{required withstand}} = U_{\text{mains transient}}$$

Rule 2) If the peak **WORKING VOLTAGE**, U_{pw} , is greater than the peak value of the nominal a.c. **MAINS** voltage, the **REQUIRED WITHSTAND VOLTAGE** is the mains transient voltage determined in 3.2.1.1.1, plus the difference between the peak **WORKING VOLTAGE** and the peak value of the nominal a.c. **MAINS** voltage.

$$U_{\text{required withstand}} = U_{\text{mains transient}} + U_{pw} - U_{\text{mains peak}}$$

- **SECONDARY CIRCUIT** whose **PRIMARY CIRCUIT** receives the full **MAINS** transient:

NOTE

For certain constructions that have been proven to be safe, this method might lead to unacceptable clearance values (without the measurement).

For insulation in such a **SECONDARY CIRCUIT**, the **REQUIRED WITHSTAND VOLTAGE** shall be determined as follows:

The above rules 1) and 2) are applied, with the **MAINS** transient voltage determined in 3.2.1.1.1 replaced by a voltage that is one step smaller in the following list:

330, 500, 800, 1 500, 2 500, 4 000, 6 000 and 8 000 V peak

However, this reduction is not permitted for a floating **SECONDARY CIRCUIT** unless it is in equipment with a main protective earthing terminal and is separated from its **PRIMARY CIRCUIT** by an earthed metal screen, connected to protective earth in accordance with 3.3.

Alternatively, the above rules 1) and 2) are applied but the voltage determined by measurement, see 3.2.1.1.1, is taken as the **MAINS** transient voltage.

- **PRIMARY CIRCUITS** and **SECONDARY CIRCUITS** not receiving the full **MAINS** transient:

For insulation in such **PRIMARY CIRCUITS** or **SECONDARY CIRCUITS**, the **REQUIRED WITHSTAND VOLTAGE**, ignoring the effect of transients coming from any other source, is determined as follows. The above rules 1) and 2) are applied, but a voltage determined by measurement, see 3.2.1.1.1, is taken as the **MAINS** transient voltage.

- **SECONDARY CIRCUIT** supplied by a d.c. source having capacitive filtering:

For insulation in any earthed **SECONDARY CIRCUIT** supplied by a d.c. source with capacitive filtering, the **REQUIRED WITHSTAND VOLTAGE** shall be taken as equal to the d.c. voltage.

3.2.1.1.4 Determination of minimum clearances

For the determination of minimum clearances up to 2 000 m above sea level table 3.4 applies.

For equipment to be operated at more than 2 000 m above sea level, table A.2 of IEC 60664-1 shall be used instead of table 3.4.

Table 3.4 - Minimum clearances up to 2 000 m above sea level

Required withstand voltage	Minimum clearances in air	
	basic insulation and supplementary insulation	reinforced insulation
≤ 400 V peak or d.c.	0,2 mm (0,1 mm)	0,4 mm (0,2 mm)
≤ 800 V peak or d.c.	0,2 mm	0,4 mm
≤ 1 000 V peak or d.c.	0,3 mm	0,6 mm
≤ 1 200 V peak or d.c.	0,4 mm	0,8 mm
≤ 1 500 V peak or d.c.	0,8 mm (0,5 mm)	1,6 mm (1 mm)
≤ 2 000 V peak or d.c.	1,3 mm (1 mm)	2,6 mm (2 mm)
≤ 2 500 V peak or d.c.	2 mm (1,5 mm)	4 mm (3 mm)
≤ 3 000 V peak or d.c.	2,6 mm (2 mm)	5,2 mm (4 mm)
≤ 4 000 V peak or d.c.	4 mm (3 mm)	6 mm
≤ 6 000 V peak or d.c.	7,5 mm	11 mm
≤ 8 000 V peak or d.c.	11 mm	16 mm
≤ 10 000 V peak or d.c.	15 mm	22 mm
≤ 12 000 V peak or d.c.	19 mm	28 mm
≤ 15 000 V peak or d.c.	24 mm	36 mm
≤ 25 000 V peak or d.c.	44 mm	66 mm
≤ 40 000 V peak or d.c.	80 mm	120 mm
≤ 50 000 V peak or d.c.	100 mm	150 mm
≤ 60 000 V peak or d.c.	120 mm	180 mm
≤ 80 000 V peak or d.c.	173 mm	260 mm
≤ 100 000 V peak or d.c.	227 mm	340 mm

1. Except in **PRIMARY CIRCUITS** in 3.2.1.1.1, linear interpolation is permitted between two voltages, the calculated minimum **CLEARANCES** being rounded up to the next higher 0,1 mm increment.

2. The values in parentheses are applicable only if manufacturing is subjected to a quality control programme. In particular, **DOUBLE INSULATION** and **REINFORCED INSULATION** shall be subjected to routine testing for dielectric strength.

3. Compliance with a **CLEARANCE** in **SECONDARY CIRCUITS** value of 8,4 mm or greater is not required if the **CLEARANCE** path is:

- entirely through air; or
- wholly or partly along the surface of an insulation of Material Group I ;

NOTE
Material Groups are defined in IEC 60664-1.

and the insulation involved passes a dielectric strength test according to 3.2.3.1.3, using:

- an a.c. test voltage whose r.m.s. value is equal to 1,06 times the peak **WORKING VOLTAGE**, or
- a d.c. test voltage equal to the peak value of the a.c. test voltage prescribed above

If the **CLEARANCE** path is partly along the surface of a material that is not Material Group I, the dielectric strength test is conducted in the air gap only.

3.2.1.2 Compliance criteria

Each **CLEARANCE** shall be equal or greater than the minimum dimensions given in table 3.4, using the value of **REQUIRED WITHSTAND VOLTAGE** determined according to 3.2.1.1.

3.2.2 Creepage distance

To limit current flow along the surface of insulation of a certain material group, which may result from conductive contamination (**POLLUTION DEGREE**), a minimum **CREEPAGE DISTANCE** in accordance with the values specified in table 3.5 shall be provided taking into consideration the conditions specified under the table.

The **CREEPAGE DISTANCE** shall not be less than the applicable **CLEARANCE** as determined in 3.2.1.

NOTE

***CREEPAGE DISTANCES**, smaller than those specified, are allowed but are subjected to a short circuit during which accessible parts shall not become **HAZARDOUS LIVE**.*

3.2.2.1 Test Methodology.

Compliance is checked by measuring the **WORKING VOLTAGE** and the **CREEPAGE DISTANCE** between the **HAZARDOUS LIVE** parts and accessible conductive parts, subject to the following conditions:

- Any movable parts are placed in the most unfavourable position.
- The most unfavourable combination of alternative parts and their position shall be used, e.g. the largest cross sectional area specified for a non detachable power cord connected.

For the **WORKING VOLTAGE** to be used in determining **CREEPAGE DISTANCES**:

- the actual r.m.s. or d.c. value shall be used;
- if the d.c. value is used, any superimposed ripple shall not be taken into account;
- short term disturbances (e.g. transients) and short term conditions (e.g. cadenced ringing signals) shall not be taken into account.

For equipment incorporating ordinary **NON-DETACHABLE POWER SUPPLY CORDS**, **CREEPAGE DISTANCE** measurements are made with supply conductors of the largest cross-sectional area specified in table 5.5 and also without conductors.

When measuring the distances account shall be taken of annex Q.

3.2.2.2 Compliance criteria

The distances measured shall not be less than the appropriate minimum values as specified in table 3.5.

Table 3.5 - Minimum creepage distance (mm)

Working voltage	Basic insulation and supplementary insulation						
	Pollution Degree 1	Pollution Degree 2			Pollution Degree 3		
	Material Group	Material Group			Material Group		
	I, II, IIIa or IIIb	I	II	IIIa or IIIb	I	II	IIIa or IIIb
50 V r.m.s. or d.c.	Use the CLEARANCE from the appropriate table	0,6 mm	0,9 mm	1,2 mm	1,5 mm	1,7 mm	1,9 mm
100 V r.m.s. or d.c.		0,7 mm	1,0 mm	1,4 mm	1,8 mm	2,0 mm	2,2 mm
125 V r.m.s. or d.c.		0,8 mm	1,1 mm	1,5 mm	1,9 mm	2,1 mm	2,4 mm
150 V r.m.s. or d.c.		0,8 mm	1,1 mm	1,6 mm	2,0 mm	2,2 mm	2,5 mm
200 V r.m.s. or d.c.		1,0 mm	1,4 mm	2,0 mm	2,5 mm	2,8 mm	3,2 mm
250 V r.m.s. or d.c.		1,3 mm	1,8 mm	2,5 mm	3,2 mm	3,6 mm	4,0 mm
300 V r.m.s. or d.c.		1,6 mm	2,2 mm	3,2 mm	4,0 mm	4,5 mm	5,0 mm
400 V r.m.s. or d.c.		2,0 mm	2,8 mm	4,0 mm	5,0 mm	5,6 mm	6,3 mm
600 V r.m.s. or d.c.		3,2 mm	4,5 mm	6,3 mm	8,0 mm	9,0 mm	10,0 mm
800 V r.m.s. or d.c.		4,0 mm	5,6 mm	8,0 mm	10,0 mm	11,0 mm	12,5 mm
1 000 V r.m.s. or d.c.	5,0 mm	7,1 mm	10,0 mm	12,5 mm	14,0 mm	16,0 mm	

Linear interpolation is permitted between the nearest two points, the calculated spacing being rounded to the next higher 0,1 mm increment.

For **REINFORCED INSULATION**, the values for **CREEPAGE DISTANCE** are twice the values for **BASIC INSULATION**.

For glass, mica, ceramic or similar materials it is permitted to use minimum **CREEPAGE DISTANCES** equal to the applicable **CLEARANCES**.

Material Groups are classified as follows:

- Material Group I $600 \leq \text{CTI}$ (Comparative tracking index)
- Material Group II $400 \leq \text{CTI} < 600$
- Material Group IIIa $175 \leq \text{CTI} < 400$
- Material Group IIIb $100 \leq \text{CTI} < 175$

The Material Group is verified by evaluation of the test data for the material according to IEC 60112 using 50 drops of solution A.

If the Material Group is not known, it can be determined by the test for the proof tracking index (PTI) as detailed in IEC 60112, OR Material Group IIIb can be assumed.

3.2.3 Solid insulation, general requirements

Insulating material

The insulation of **HAZARDOUS LIVE** parts shall not be provided by hygroscopic materials.

Under **NORMAL OPERATING CONDITIONS** the electrical and mechanical strength of insulating material shall not degrade due to the temperature.

The insulation between accessible parts or parts connected to them and **HAZARDOUS LIVE** parts shall be able to withstand surges due to voltages present at the antenna terminal.

Distance through insulation

Distance through insulation applies to **WORKING VOLTAGES** greater than 50 Vrms (71 V peak or dc) and shall be dimensioned as follows:

- **BASIC INSULATION** has no minimum thickness requirement;
- **SUPPLEMENTARY INSULATION** shall have a minimum thickness of 0,4 mm;

- **REINFORCED INSULATION** shall have a minimum thickness of 0,4 mm when not subject to any mechanical stress which, at nominal operating temperature, would be likely to lead to deformation or deterioration of the insulating material.

Thin sheet material

The distance through insulation requirements do not apply to insulation made up of thin sheet material, provided that it is used within the equipment **ENCLOSURE** and is not subject to handling or abrasion during **NORMAL OPERATING CONDITIONS**, and one of the following applies:

- **SUPPLEMENTARY INSULATION** comprises at least two layers of material, each of which will pass the dielectric strength test for **SUPPLEMENTARY INSULATION**; or
- **SUPPLEMENTARY INSULATION** comprises three layers of material for which all combinations of two layers together will pass the dielectric strength test for **SUPPLEMENTARY INSULATION**; or
- **REINFORCED INSULATION** comprises at least two layers of material, each of which will pass the dielectric strength test for **REINFORCED INSULATION**; or
- **REINFORCED INSULATION** comprises three layers of material for which all combinations of two layers will pass the dielectric strength test for **REINFORCED INSULATION**.

The solvent based enamel on winding wire which is normally used in transformer construction is not considered to be insulation in thin sheet material.

There is no requirement for all layers of insulation to be of the same material.

Internal wiring

Insulation of internal wiring between **HAZARDOUS LIVE** conductors and accessible parts or between **HAZARDOUS LIVE** parts and conductors in wires or cables connected to accessible conductive parts shall have a thickness of at least 0,4 mm if made of polyvinyl chloride. Other materials are allowed provided that they withstand the dielectric strength test specified in 3.2.3.1.3 and that their thickness ensures an equivalent mechanical strength, where the construction so requires.

NOTE

For example a polytetrafluoroethylene (PTFE) insulation having a thickness of at least 0,24 mm is considered to fulfil this requirement.

In addition, for internal wires in **CLASS II** circuits, in case the **HAZARDOUS LIVE** conductors respectively parts are conductively connected to the **MAINS**, either the **BASIC INSULATION** or **SUPPLEMENTARY INSULATION** shall comply with the requirement above with respect to the insulation. The other insulation shall comply with the dielectric strength test as specified in 3.2.3.1.3 for **BASIC INSULATION** or **SUPPLEMENTARY INSULATION**.

3.2.3.1 Test methodology

Compliance is checked by inspection and, if the data does not confirm that the material is non-hygroscopic, by the following tests.

Compliance with the insulation degradation requirement is checked by the temperature test of 3.2.3.1.2.

Compliance is checked by the test of 3.2.3.1.4.

The test is not required for **CLASS I** equipment provided the protective earth is connected to the antenna input circuit.

Compliance is checked by measuring the distance through insulation and applying the appropriate dielectric strength test of 3.2.3.1.3.

3.2.3.1.1 Humidity test

The humidity conditioning is carried out for 48 h in a cabinet or room containing air with a relative humidity of 90 % to 95 %. The temperature of the air, at all places where samples can be located, is maintained within 2 °C of any value *t* between 20 °C and 30 °C such that condensation does not occur. During this conditioning the component or subassembly is not energized.

For tropical conditions the time duration shall be 120 h at a temperature of 40 ± 2 °C and a relative humidity of 90 % to 95 %.

Before the humidity conditioning the sample is brought to a temperature between the specified temperature t and $(t + 4)$ °C.

Immediately after this preconditioning, the specimen shall be submitted to the dielectric strength test according to 3.2.3.1.3.

3.2.3.1.2 Temperature test

The temperature rise of the various parts is determined under the following conditions:

- Taking into account the conditions of B.4, the equipment or parts of the equipment are operated under **NORMAL OPERATING CONDITIONS** as follows:
 - for continuous operation, until steady conditions are established;
 - for **INTERMITTENT OPERATION**, until steady conditions are established, the “on” and “off” periods being the rated “on” and “off” periods;
- for **SHORT-TIME OPERATION**, for the **RATED OPERATING TIME**.
- It is permitted to test components and other parts independently provided that the test conditions applicable to the equipment are adhered to.
- Equipment intended for building-in or rack mounting or for incorporation in larger equipment is tested under the most adverse conditions, actual or simulated, permitted in the ‘manufacturer’s installation instructions.
- During the test, **THERMAL CUT-OUTS** shall not operate and sealing compound, if any, shall not flow out.

The temperature rise of electrical insulation (other than that of windings), failure of which could cause a hazard, is measured on the surface of the insulation at a point close to the heat source.

NOTE

For temperature rise of windings, see B.6.

After the preconditioning, the specimen shall be submitted to the dielectric strength test according to 3.2.3.1.3.

3.2.3.1.3 Dielectric strength test

The test voltages for the dielectric strength test shall be defined according to table 3.6 and figure 3.1.

Table 3.6 - Test voltages for dielectric strength test

Insulation	a.c. test voltage (peak) or d.c. test voltage
1 Between parts of different polarity connected to the a.c. MAINS	For rated a.c. MAINS voltages ≤ 150 V (r.m.s.): 1 410 V For rated a.c. MAINS voltages > 150 V (r.m.s.): 2 120 V
2 Between parts separated by BASIC INSULATION or by SUPPLEMENTARY INSULATION	Curve A of figure 3.1
3 Between parts separated by REINFORCED INSULATION	Curve B of figure 3.1

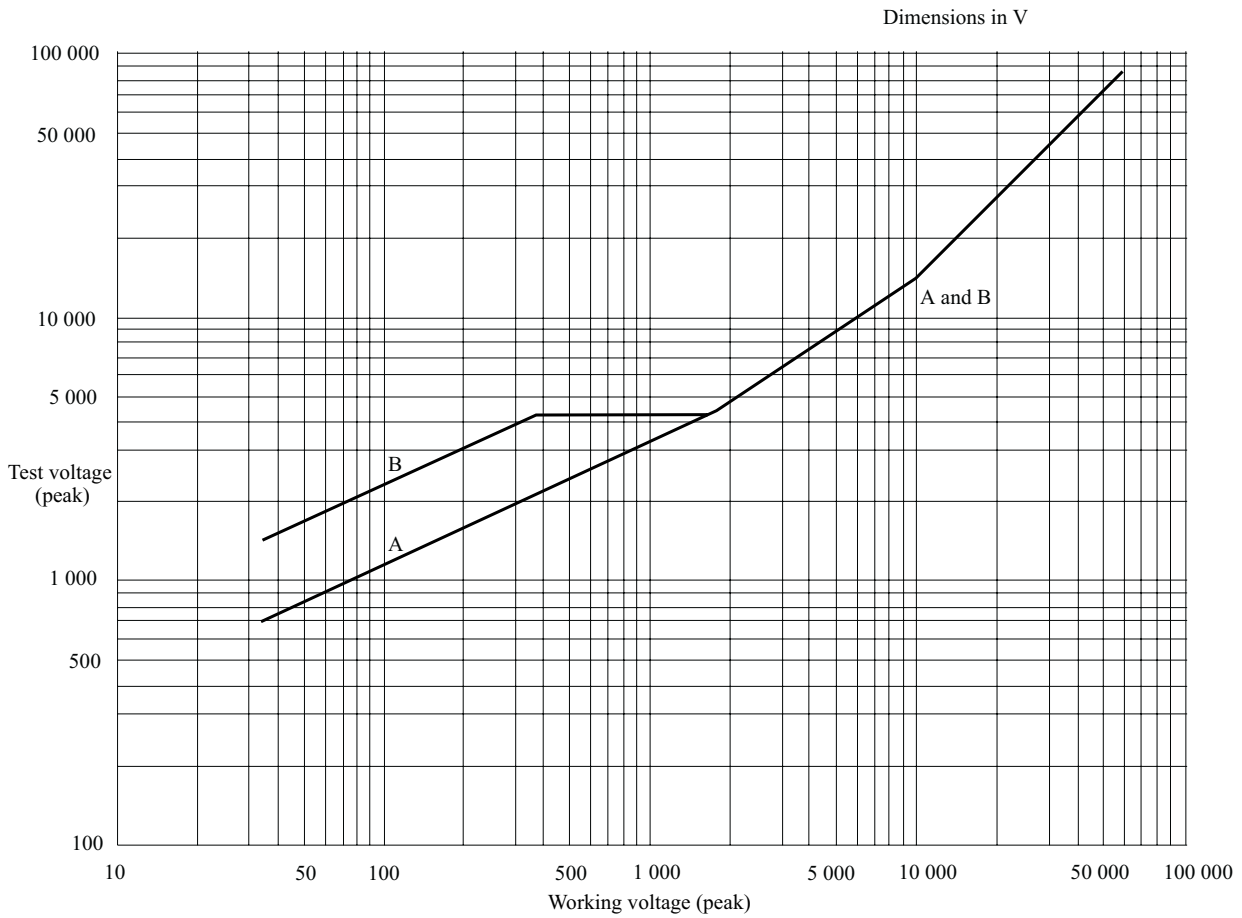

Curves A and B of figure 3.1 are defined by the following points:

Working voltage U (peak)	Test voltage (peak)	
	Curve A	Curve B
35 V	707 V	1 410 V
354 V		4 240 V
1 410 V	3 980 V	
10 kV	15 kV	15 kV
>10 kV	1,5 U V	1,5 U V

Figure 3.1 - Test voltages

3.2.3.1.4 Antenna terminals

The insulation between terminals for the connection of an antenna and the MAINS terminals is subjected to 50 discharges at a maximum rate of 12/min, from a test generator reference 3 of table D.1 with $U_c = 10$ kV .

NOTE

During the test, the equipment should not be energized.

After the test the equipment is subjected to the dielectric strength test of 3.2.3.1.3.

3.2.3.2 Compliance criteria

The sample shall pass the test of 3.2.3.1.1.

During the test of 3.2.3.1.2 the limits of the table 3.7 shall not be exceeded.

There shall be no breakdown of the insulation during the dielectric strength test of 3.2.3.1.3.

For **SUPPLEMENTARY INSULATION** or **REINFORCED INSULATION** the distance measured shall not be less than 0,4 mm and there shall be no breakdown of the insulation during the dielectric strength test.

The correct number of layers of insulation of adequate dielectric strength shall be used.

Table 3.7 - Temperature-rise limits

Parts	Maximum temperature rise	
	normal operating condition	abnormal operating condition
Insulation, including winding insulation:		
• of Class A material	75 K	125 K
• of Class E material	90 K	140 K
• of Class B material	95 K	150 K
• of Class F material	115 K	165 K
• of Class H material	140 K	185 K
	<i>see conditions 1), 2) and 4)</i>	
Winding wires insulated with:		
• non-impregnated silk, cotton, etc.	55 K	75 K
• impregnated silk, cotton, etc.	70 K	100 K
• oleoresinous materials	70 K	135 K
• polyvinyl-formaldehyde or polyurethane resins	85 K	150 K
• polyester resins	120 K	155 K
• polyesterimide resins	145 K	180 K
Synthetic rubber or PVC insulation of internal and external wiring including power supply cords		
• without T-marking	60 K	100 K
• with T-marking	T - 25	T
Other thermoplastic insulation ³⁾	softening temperature - 10 K	softening temperature

Conditions applicable to table 3.7

- 1) If temperature rises of windings are determined by thermocouples, these figures are reduced by 10 K except in the case of motors.
- 2) The classification of insulating materials (classes A, E, B, F and H) is in accordance with IEC 60085.
- 3) Due to their wide variety, it is not possible to specify permitted temperature rises for thermoplastic materials. In order to determine the softening temperature for thermoplastic materials, the test of ISO 306 B50 shall be used. If the material is not known or if the actual temperature of the parts exceeds the permissible temperature limit the test described under A) shall be used.
 - A. the softening temperature of the material is determined on a separate specimen, under the conditions specified in ISO 306 with a heating rate of 50°C/h and modified as follows:
 - the depth of penetration is 0,1 mm;
 - the total thrust of 10 N is applied before the dial gauge is set to zero or its initial reading noted.
 - B. the temperature limits to be considered for determining the temperature rises are:
 - under **NORMAL OPERATING CONDITIONS**, a temperature of 10 K below the softening temperature;
 - under fault conditions, the softening temperature itself.

If the required softening temperature, as obtained under A), exceeds 120 °C, the nature of the material is the governing factor.
- 4) For each material, account should be taken of data for that material to determine the appropriate maximum temperature rise.

3.2.4 Coated Printed Circuit Boards

3.2.4.1 General

Coatings on rigid printed boards can be used in three ways to allow reduced distances between conductors:

- I. This corresponds to coating A of IEC 60664-3. The coating is only relied on to improve the environment to **POLLUTION DEGREE 1** between printed wiring conductors under the coating allowing reduced spacings. The requirements of 3.2.6 apply.
- II. This corresponds to 3.2.4.2, using the minimum separation distances of table 3.9. A routine test for dielectric strength is required for **REINFORCED INSULATION** and **SUPPLEMENTARY INSULATION**.
- III. This corresponds to coating B of IEC 60664-3. The conductors are enclosed in solid insulation consisting of the base material and the coating, so that air is totally and permanently excluded. **CLEARANCES** and **CREEPAGE DISTANCES** do not exist and there are no minimum separation distances under the coating. This applies only to **BASIC INSULATION**.

The table 3.8 summarises the requirements.

Table 3.8 - Summary of requirements for coated printed boards

	Coating Type		
	I	II	III
Requirements covered in:	3.2.6	3.2.4.2	IEC 60664-3
Concept covered in IEC 60664-3	Y	N <i>(Combines requirements for coating types A and B for BASIC INSULATION)</i>	Y
Separation distance characteristics	CREEPAGE DISTANCES and CLEARANCES for POLLUTION DEGREE 1	Separation distances in table 3.9	No minimum separation distances
Consider transients for dimensioning	Y	N	N
Insulation grades	N	B/S/R	B
Routine dielectric strength test	N	Y	Y
Thermal cycling	Y	Y	Y
Thermal ageing	N	Y	Y
Abrasion resistance test	N	Y	Y

3.2.4.2 Coated boards with minimum separation distances

For printed boards whose surface conductors are coated with a suitable coating material, the minimum separation distances of table 3.9 are applicable to conductors before they are coated, subject to the following requirements.

Either one or both conductive parts and at least 80 % of the distances over the surface between the conductive parts shall be coated. Between any two uncoated conductive parts and over the outside of the coating, the minimum distances as determined in 3.2.2 apply.

The values in table 3.9 shall be used only if manufacturing is subject to a quality control programme. In particular, **DOUBLE INSULATION** and **REINFORCED INSULATION** shall be subject to routine testing for dielectric strength.

In default of the above conditions, the requirements of 3.2.1, 3.2.2 and 3.2.3 shall apply.

The coating process, the coating material and the base material shall be such that uniform quality is assured and the separation distances under consideration are effectively protected.

Table 3.9 - Minimum separation distances for coated printed boards

Working voltage	Basic insulation or supplementary insulation	Reinforced insulation
≤ 63 V r.m.s. or d.c.	0,1 mm	0,2 mm
≤ 125 V r.m.s. or d.c.	0,2 mm	0,4 mm
≤ 160 V r.m.s. or d.c.	0,3 mm	0,6 mm
≤ 200 V r.m.s. or d.c.	0,4 mm	0,8 mm
≤ 250 V r.m.s. or d.c.	0,6 mm	1,2 mm
≤ 320 V r.m.s. or d.c.	0,8 mm	1,6 mm
≤ 400 V r.m.s. or d.c.	1,0 mm	2,0 mm
≤ 500 V r.m.s. or d.c.	1,3 mm	2,6 mm
≤ 630 V r.m.s. or d.c.	1,8 mm	3,6 mm
≤ 800 V r.m.s. or d.c.	2,4 mm	3,8 mm
≤ 1 000 V r.m.s. or d.c.	2,8 mm	4,0 mm
≤ 1 250 V r.m.s. or d.c.	3,4 mm	4,2 mm
≤ 1 600 V r.m.s. or d.c.	4,1 mm	4,6 mm
≤ 2 000 V r.m.s. or d.c.	5,0 mm	5,0 mm
≤ 2 500 V r.m.s. or d.c.	6,3 mm	6,3 mm
≤ 3 200 V r.m.s. or d.c.	8,2 mm	8,2 mm
≤ 4 000 V r.m.s. or d.c.	10 mm	10 mm
≤ 5 000 V r.m.s. or d.c.	13 mm	13 mm
≤ 6 300 V r.m.s. or d.c.	16 mm	16 mm
≤ 8 000 V r.m.s. or d.c.	20 mm	20 mm
≤ 10 000 V r.m.s. or d.c.	26 mm	26 mm
≤ 12 500 V r.m.s. or d.c.	33 mm	33 mm
≤ 16 000 V r.m.s. or d.c.	43 mm	43 mm
≤ 20 000 V r.m.s. or d.c.	55 mm	55 mm
≤ 25 000 V r.m.s. or d.c.	70 mm	70 mm
≤ 30 000 V r.m.s. or d.c.	86 mm	86 mm

For voltages between 2 000 V and 30 000 V, linear interpolation is permitted between the nearest two points, the calculated spacing being rounded up to the next higher 0,1 mm increment.

3.2.4.3 Test methodology

Compliance is checked by measurement taking into account figure Q.13, and by the following tests.

Sample preparation and preliminary inspection

Three sample boards (or, for 3.2.5, two components and one board) identified as samples 1, 2 and 3 are required. It is permitted to use either actual boards or specially produced samples with representative coating and minimum separations. Each sample board shall be representative of the minimum separations used, and coated. Each sample is subjected to the full sequence of manufacturing processes, including soldering and cleaning, to which it is normally subjected during equipment assembly.

Thermal cycling

Sample 1 is subjected 10 times to the following sequence of temperature cycles:

- 68 h** at $T_1 \text{ } ^\circ\text{C} \pm 2 \text{ } ^\circ\text{C}$
- 1 h** at $25 \text{ } ^\circ\text{C} \pm 2 \text{ } ^\circ\text{C}$
- 2 h** at $0 \text{ } ^\circ\text{C} \pm 2 \text{ } ^\circ\text{C}$
- ≥ 1 h** at $25 \text{ } ^\circ\text{C} \pm 2 \text{ } ^\circ\text{C}$

$T_1 = T_2 + T_{mra} - T_{amb} + 10 \text{ K}$, measured in accordance with B.5 and, where relevant, B.6, or $100 \text{ }^\circ\text{C}$, whichever is higher. However, the 10 K margin is not added if the temperature is measured by an embedded thermocouple.

T_2 is the temperature of the parts measured during the test of 5.2.1.1.

The significance of T_{mra} and T_{amb} are as given in B.5.

The period of time taken for the transition from one temperature to another is not specified, but the transition is permitted to be gradual.

Thermal ageing

Sample 2 shall be aged in a full draught oven at a temperature and for a time duration chosen from the graph of figure 3.2 using the temperature index line that corresponds to the maximum operating temperature of the coated board. The temperature of the oven shall be maintained at the specified temperature $\pm 2 \text{ }^\circ\text{C}$. The temperature used to determine the temperature index line is the highest temperature on the board where safety is involved.

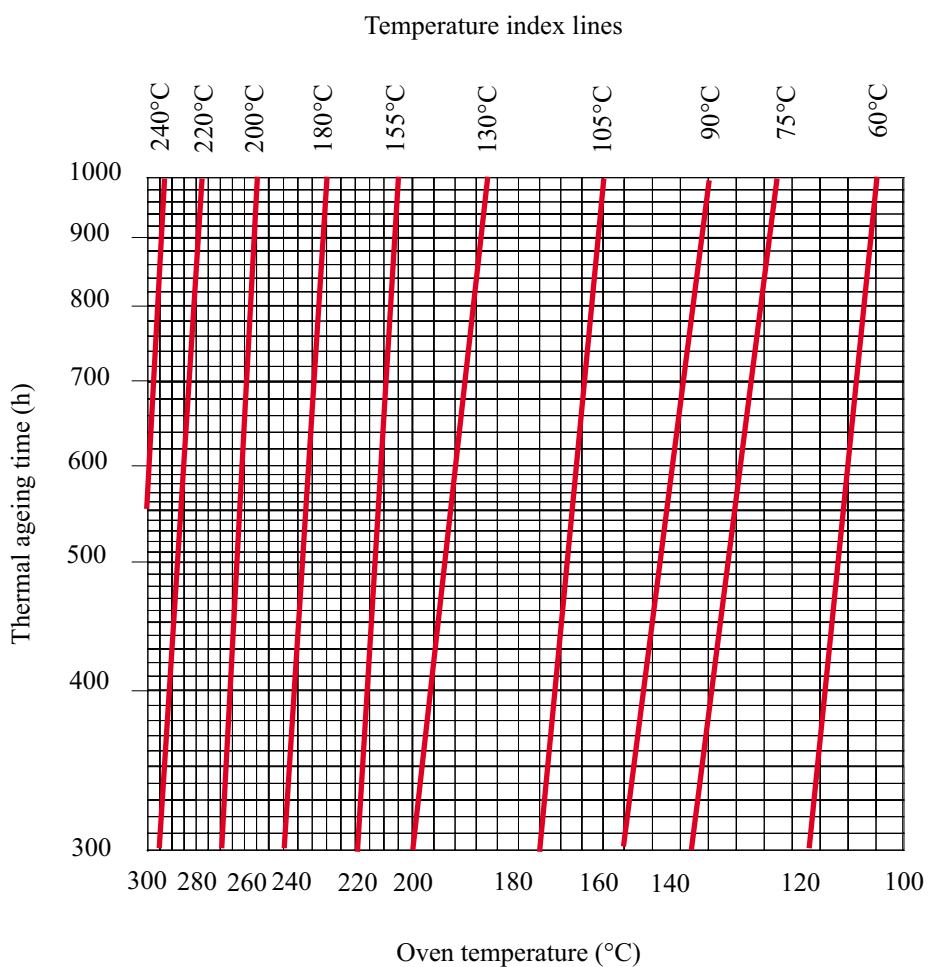

99-0005-A

Figure 3.2 - Thermal ageing time

Dielectric strength test

Samples 1 and 2 are then subjected to the test of 3.2.3.1.1.

Abrasion test

Sample board 3 is subjected to the following test.

Scratches are made across five pairs of conducting parts and the intervening separations at points where the separations will be subject to the maximum potential gradient during the tests.

The scratches are made by means of a hardened steel pin, the end of which has the form of a cone having a tip angle of 40° , its tip being rounded and polished, with a radius of $0,25 \text{ mm} \pm 0,02 \text{ mm}$.

Scratches are made by drawing the pin along the surface in a plane perpendicular to the conductor edges at a speed of $20 \text{ mm/s} \pm 5 \text{ mm/s}$ as shown in figure 3.3. The pin is so loaded that the force exerted along its axis is $10 \text{ N} \pm 0,5 \text{ N}$. The scratches shall be at least 5 mm apart and at least 5 mm from the edge of the specimen.

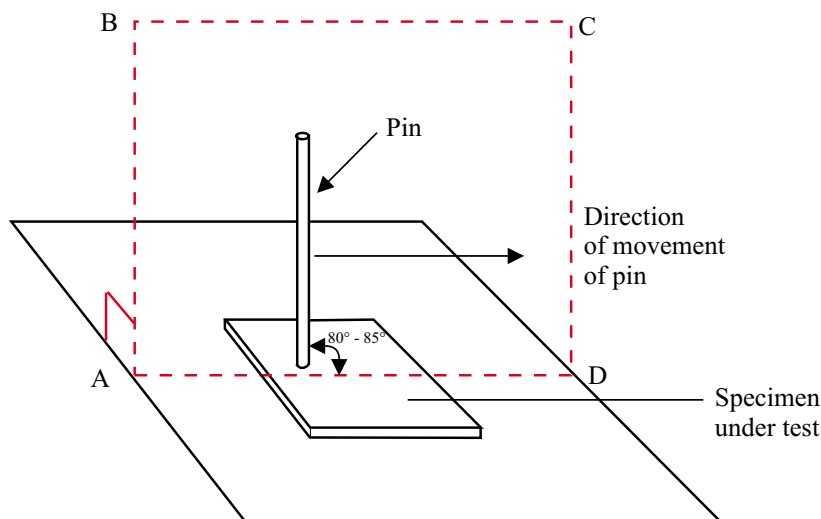

93-0073-B

The pin is in the plane A B C D which is perpendicular to the specimen under test.

Figure 3.3 - Abrasion resistance test for coating layers

3.2.4.4 Compliance criteria

When visually inspected, the boards shall show no evidence of pinholes or bubbles in the coating or breakthrough of conductive tracks at corners.

After the abrasion test, the coating layer shall neither have loosened nor have been pierced, and it shall withstand an dielectric strength test as specified in 3.2.3.1.3 between conductors. In the case of metal core printed boards, the substrate is one of the conductors.

3.2.5 External terminations of components

The requirements of 3.2.1, 3.2.2 and 3.2.3 are applicable to the spacings between external terminations of components unless they have a coating of material satisfying the requirements of 3.2.4.2 including quality control requirements. In such a case, the minimum separation distances of table 3.10 apply to the component before coating. Between any two uncoated conductive parts and over the outside of the coating, the minimum distances for **CLEARANCE** and **CREEPAGE DISTANCE** shall be applied.

If coatings are used over terminations to increase effective **CREEPAGE DISTANCES** and **CLEARANCES**, the mechanical arrangement and rigidity of the terminations shall be adequate to ensure that, during normal handling, assembly into equipment and subsequent use, the terminations will not be subject to deformation which would crack the coating or reduce the separation distances between conductive parts below the values in table 3.10.

3.2.5.1 Test Methodology

Compliance is checked by inspection taking into account figure Q.12, and by applying the sequence according to 3.2.4.3. This test is carried out on a completed assembly including the component(s).

The abrasion resistance test of 3.2.4.3 is carried out on a specially prepared sample printed board as described for sample 3 in 3.2.4.3, except that the separation between the conductive parts shall be representative of the minimum separations and maximum potential gradients used in the assembly.

3.2.5.2 Compliance criteria

When visually inspected, the terminations shall show no evidence of pinholes or bubbles in the coating.

3.2.6 Enclosed and sealed components

For components or subassemblies which are adequately enclosed by enveloping or hermetic sealing to prevent ingress of dirt and moisture, the values of **CLEARANCE** and **CREEPAGE DISTANCES** for **POLLUTION DEGREE 1** apply.

Examples of such constructions include parts in boxes that are hermetically sealed by adhesive or otherwise, and parts enveloped in a dip coat.

3.2.6.1 Test methodology

Compliance is checked by inspection from the outside, measurement and, if necessary, by test. A component or subassembly is considered to be adequately enclosed if a sample passes the following sequence of tests.

The sample is subjected 10 times to the following sequence of temperature cycles:

68 h	at T_1 °C ± 2 °C
1 h	at 25 °C ± 2 °C
2 h	at 0 °C ± 2 °C
≥ 1 h	at 25 °C ± 2 °C

$T_1 = T_2 + T_{mra} - T_{amb} + 10$ K, measured in accordance with annex B.5 and, where relevant, annex B.6, or 85 °C, whichever is higher. However, the 10 K margin is not added if the temperature is measured by an embedded thermocouple or by the resistance method.

T_2 is the temperature of the parts measured during the test of 5.2.1.1.

The significance of T_{mra} and T_{amb} are as given in annex B.5.

The period of time taken for the transition from one temperature to another is not specified, but the transition is permitted to be gradual.

The sample is allowed to cool to room temperature and is subjected to the humidity test of 3.2.3.1.1

For transformers, magnetic couplers and similar devices, where insulation is relied upon for safety, a voltage of 500 V r.m.s at 50 Hz to 60 Hz is applied between windings during the thermal cycling conditioning.

3.2.6.2 Compliance criteria

No evidence of insulation breakdown shall occur during the tests.

3.2.7 Spacings filled by insulating compound

Where distances between conductive parts are filled with insulating compound, including where insulation is reliably cemented together with insulating compound, so that **CLEARANCES** and **CREEPAGE DISTANCES** do not exist, only the requirements for distance through insulation of 3.2.3 apply.

NOTE 1

Some examples of such treatment are variously known as "potting", "encapsulation" and "vacuum impregnation".

NOTE 2

Acceptable forms of construction include:

- *components or subassemblies which are treated with an insulating compound that fills voids;*
- *internal insulation of multi-layer printed boards.*

3.2.7.1 Test methodology

Compliance is checked by inspection, measurement and test. There is no measurement of **CLEARANCES** and **CREEPAGE DISTANCES** if samples pass the thermal cycling, humidity conditioning and dielectric strength tests applied as follows:

- for components where insulating compound forms solid insulation between conductive parts, a single finished component is tested. The tests are followed by inspection, including sectioning, and measurement.
- for components where insulating compound forms a cemented joint with other insulating parts, the reliability of the joint is checked by subjecting three samples to the dielectric strength test of 3.2.3.1.3 applied directly to the cemented joint. If a winding of solvent-based enamelled wire is used in the component, it is replaced for the test by a metal foil or by a few turns of bare wire, placed close to the cemented joint. The three samples are then tested as follows:
 - one of sample is subjected 10 times to the following sequence of temperature cycles:

68 h at T_1 °C ± 2 °C

1 h at 25 °C ± 2 °C

2 h at 0 °C ± 2 °C

≥ 1 h at 25 °C ± 2 °C

$T_1 = T_2 + T_{mra} - T_{amb} + 10$ K, measured in accordance with annex B.5 and, where relevant, annex B.6, or 85 °C, whichever is higher. However, the 10 K margin is not added if the temperature is measured by an embedded thermocouple or by the resistance method.

T_2 is the temperature of the parts measured during the test of 5.2.1.1.

The significance of T_{mra} and T_{amb} are as given in annex B.5.

The period of time taken for the transition from one temperature to another is not specified, but the transition is permitted to be gradual.

Immediately after the last period at highest temperature during thermal cycling the sample is subjected to the dielectric strength test of 3.2.3.1.3, except that the test voltage is multiplied by 1,6;

- the other samples are subjected to the humidity test of 3.2.3.1.1, except that the test voltage is multiplied by 1,6.

3.2.7.2 Compliance criteria

There shall be neither cracks nor voids in the insulating compound such as would affect compliance with 3.2.3.

3.2.8 Wound components without interleaved insulation

Insulated winding wires of wound components, the insulation of which is providing **BASIC INSULATION**, **SUPPLEMENTARY INSULATION** or **REINFORCED INSULATION** shall meet the following requirements:

- Where the insulation on the winding wire is used to provide **BASIC INSULATION** or **SUPPLEMENTARY INSULATION** in a wound component, the insulated wire shall comply with annex K.

NOTE

Examples of insulation of winding wire complying with Annex K are polyamide and FEP.

The insulation of the conductors shall consist of two or more wrapped or extruded layers.

- Where the insulation on the winding wire is used to provide **REINFORCED INSULATION** in a wound component, the insulated wire shall comply with annex K.

The insulation of the conductors shall consist of three or more wrapped or extruded layers.

- If the wire is insulated with two or more spirally wrapped layers of tape, the overlap of layers shall be adequate to ensure continued overlap during manufacture of the wound component. Layers of tape shall be sealed if **CREEPAGE DISTANCES** between layers, as wrapped, does not comply with 3.2.1.

NOTE

For wires insulated by an extrusion process, sealing is inherent to the process.

- Where two insulated wires or one bare and one insulated wire are in contact inside of a wound component, crossing each other at an angle between 45° and 90° and subject to winding tension, one of the following applies:
 - physical separation in the form of insulating sleeving or using double the required number of insulation layers is required, or
 - the wound component meets the tests of 3.2.8.1.
- The manufacturer’s documentation shall show that the wound component has been subjected to 100% routine dielectric strength testing of 3.2.3.1.3 , using the appropriate value of the test voltage.

3.2.8.1 Test Methodology

Except where 3.2.8 applies, the live parts of the wound component (core and windings) are subjected to the following cycling test, each cycle consisting of a heat run, a vibration test, and a humidity treatment. Measurements according to 3.2.8.1 d) are made after each cycle.

The number of specimens is 3. The specimens are subjected to 10 test cycles.

3.2.8.1.1 Heat run

Depending on the type of insulation (thermal classification), the specimens are kept in a heating cabinet for a combination of time and temperature as specified in table 3.10. The 10 cycles are carried out with the same combination.

The temperature in the heating cabinet shall be maintained within a tolerance of ± 3 °C.

Table 3.10 - Test temperature and testing time (in days) per cycle.

Test temperature	Temperature for the insulation system					
	100 °C	115 °C	120 °C	140 °C	165 °C	
220 °C					4 days	
210 °C					7 days	
200 °C					14 days	
190 °C				4 days		
180 °C				7 days		
170 °C				14 days		
160 °C			4 days			
150 °C		4 days	7 days			
140 °C		7 days				
130 °C	4 days					
120 °C	7 days					
Corresponding classification according to IEC 60085 and IEC 60216	A	E	B	F		H
Condition: the manufacturer shall specify the testing time per class used.						

3.2.8.1.2 Humidity treatment

The specimens are submitted for 2 days to the humidity conditioning of 3.2.3.1.1

3.2.8.1.3 Vibration test

Specimens are fastened to the vibration generator in their normal position of use, as specified in IEC 60068-2-6, by means of screws, clamps or straps round the component. The direction of vibration is vertical, and the severity is:

- duration: 30 min;
- amplitude: 0,35 mm;
- frequency range: 10 Hz, 55 Hz, 10 Hz;
- sweep rate: approximately one octave per minute.

3.2.8.1.4 Measurements

After each cycle, the insulation resistance is measured and the dielectric strength test of 3.2.3.1.3 is carried out.

Moreover the following test is made for transformers operated at **MAINS** frequency:

After the dielectric strength test, one input circuit is connected to a voltage equal to a test voltage of at least 1,2 times the **RATED VOLTAGE**, at double the **RATED FREQUENCY** for 5 min. No load is connected to the transformer. During the test, polyfilar windings, if any, are connected in series.

A higher test frequency may be used; the duration of the period of connection, in minutes, then being equal to 10 times the **RATED FREQUENCY** divided by the test frequency, but not less than 2 min.

After the heat tests, the specimens are allowed to cool down to ambient temperature before the humidity treatment is made.

The values of the test voltage for the dielectric test according to 3.2.3.1.3 are however reduced to 35 % of the specified values and the testing times doubled.

3.2.8.2 Compliance criteria

If, after the completion of all 10 cycles, one or more specimens have failed, the wound component is considered as not complying with the endurance test.

For wound components operated at **MAINS** frequency, there shall be no breakdown of the insulation between the turns of a winding, between input and output circuits, between adjacent input or output circuits, or between the windings and any conductive core.

A specimen is considered to comply with the test if the no-load current or the ohmic component of the no-load input deviates from the corresponding value, obtained during the initial measurement, by less than 30 %.

3.2.9 Bridging of double insulation or reinforced insulation

It is permitted to bridge **DOUBLE INSULATION** or **REINFORCED INSULATION** by:

Capacitors:

- a single capacitor complying with IEC 60384-14: 1993, subclass Y1; or
- two capacitors in series, each complying with IEC 60384-14: 1993, subclass Y2 or Y4.

Where two capacitors are used in series, they shall each be rated for the total **WORKING VOLTAGE** across the pair and shall have the same nominal capacitance value.

Resistors:

It is permitted to bridge **DOUBLE INSULATION** or **REINFORCED INSULATION** by one resistor if the resistor complies with the appropriate test of 3.2.9.1.

It is permitted to bridge **DOUBLE INSULATION** or **REINFORCED INSULATION** by two resistors in series if each resistor:

- complies with the requirements of **CREEPAGE DISTANCE** (3.2.2) and **CLEARANCE** (3.2.1) between their terminations for the total **WORKING VOLTAGE** across the pair, and
- has the same nominal resistance value,

or complies with the appropriate test of 3.2.9.1.

3.2.9.1 Test methodology

Capacitors

Compliance is checked by applying the damp heat test according to IEC 60384-14, duration 21 days.

Resistors

Compliance is checked by applying the following test on 10 resistors.

Before the test, the resistance of each specimen is measured and the sample is then subjected to the damp heat test according to IEC 60068-2-3, severity 21 days.

For resistors connected between **HAZARDOUS LIVE** parts and accessible conductive parts and for resistors bridging contact gaps of **MAINS** switches, the ten specimens are each subjected to 50 discharges at a maximum rate of 12 per minute, from a 1 nF capacitor charged to 10 kV in a test circuit as shown in reference 3 of table D.1

The value of resistance is measured when steady state is attained.

3.2.9.2 Compliance criteria

Capacitors

The capacitors shall fulfil the compliance criteria as stated in IEC 60384-1.

Resistors

The value of resistance shall not differ more than 20 % from the value measured before the damp heat test.

No failure is allowed.

3.3 Reliable earthing

For **CLASS I** equipment, accessible conductive parts, which in the event of a single insulation fault, might become **HAZARDOUS LIVE** shall be reliably connected to a protective earthing terminal within the equipment.

The protective earthing path shall be of sufficiently low impedance.

The continuity of the earthing path and the reliable fixing of any connections shall be ensured.

Contamination and degrading of the connections shall be avoided.

3.3.1 Resistance of protective earthing conductors.

The resistance of the connection between the protective earthing terminal or earthing contact, and parts requiring to be earthed, shall not exceed 0,1 ohms.

Test methodology

Compliance is checked by inspection and by application of a test current of 1.5 times the current capacity of any **HAZARDOUS LIVE** circuit at the point where failure of **BASIC INSULATION** would make the earthed part live. The test voltage shall not exceed 12 V and the test current can be either a.c. or d.c. but not more than 25 A.

The voltage drop between the protective earthing terminal or earthing contact and the part required to be earthed is measured and the resistance is calculated from the test current and this voltage drop. The resistance of the protective earthing conductor of the power supply cord is not included in the resistance measurement.

On equipment where the protective earth connection to a sub-assembly or to a separate unit is by means of one core of a multicore cable which also supplies **MAINS** power to that sub-assembly or unit, the resistance of the protective earthing conductor in that cable is not included in the resistance measurement. However, the cable is protected by a suitably rated protective device which takes into account the impedance of the cable.

Care shall be taken that the contact resistance between the tip of the measuring probe and the metal part under test does not influence the test results.

3.3.2 Continuity of earthing path.

Protective earthing conductors shall not contain switches or fuses or other devices that might interrupt continuity of the protective earthing conductor. If a system comprises **CLASS I** equipment and **CLASS II** equipment, interconnection of the equipment shall be such that the earthing connection is assured for all **CLASS I** equipment regardless of the arrangements of equipment in the system.

Test methodology

Compliance is checked by inspection.

3.3.3 Reliable fixing of any connections

Protective earthing terminal connections shall be held in place by a second fixing to reduce the chance of the main connection becoming loose and, if it does become loose, to prevent it from contacting **HAZARDOUS LIVE** parts.

Test methodology

Compliance is checked by inspection.

3.3.4 Corrosion resistance of protective earthing conductors

Conductive parts in contact at protective earthing connections shall not be subject to significant corrosion due to electrochemical action, in any storage or transport conditions as specified in the manufacturers instructions. Combinations above the line in annex P shall be avoided.

Test methodology

Compliance is checked by inspection using the electrochemical annex P as a reference.

3.3.5 Integrity of protective earth path

Protective earthing connections shall be so designed:

- that disconnection of a earth at one assembly does not break the protective earthing connection to other assemblies, and
- that they do not have to be disconnected for servicing other than the removal of the part which they protect, unless the effected part ceases to be **HAZARDOUS LIVE** at the same time.

Test methodology

Compliance is checked by inspection.

3.4 Electrical enclosures

ELECTRICAL ENCLOSURES shall have adequate mechanical strength to prevent degradation of the insulation system.

3.4.1 Test methodology

Compliance is checked by inspection and measurement.

Compliance of the mechanical strength is checked by the test of annex V.2.

3.4.2 Compliance criteria

It shall not be possible to access **HAZARDOUS LIVE** parts with the test probe B of IEC 61032.

3.5 Safety interlock system

Where **SAFETY INTERLOCKS** are applied, these shall be so designed that on entering, opening or removing an **ENCLOSURE** any accessible **HAZARDOUS LIVE** part ceases to be **HAZARDOUS LIVE** before access is gained.

Test methodology.

The application of **SAFETY INTERLOCKS** is checked by inspection and their performance is checked by tests in accordance with annex L.

3.6 Design of adequate wiring

The routing and connection of wires shall be such that the risk of an electric shock is minimized.

3.6.1 Wire routing of internal wiring

Internal wiring with a conductor carrying a **HAZARDOUS LIVE** voltage or with an insulation which could come into contact with **HAZARDOUS LIVE** parts, shall be routed and secured in such a way that mechanical damage of the insulation, in case this could result in a hazard, is prevented.

Test methodology

Compliance is checked by inspection and in case of doubt by the vibration test of 3.2.8.1.3 and by applying a force of 5 N to any part of the wire or the surroundings.

3.6.2 Wire connection

The construction shall be such that, should any wire become detached, the **CLEARANCES** and **CREEPAGE DISTANCES** are not reduced below the values specified in 3.2.1 and 3.2.2 by the natural movement of a detached wire. This requirement does not apply if there is no risk of a wire becoming detached.

NOTE

It is assumed that not more than one connection will become detached at the same time.

3.6.2.1 Test methodology

Compliance is checked by inspection and measurement of the **CREEPAGE DISTANCES** and **CLEARANCES**.

Examples of methods deemed to prevent a wire from becoming detached are:

- a) the conductor of the wire is anchored to the tag before soldering, unless breakage close to the soldering place is likely to occur as a result of vibration;
- b) wires are twisted together in a reliable manner;
- c) wires are fastened together reliably by cable ties, adhesive tapes with thermosetting adhesives according to IEC 60454, sleeves or the like;
- d) the conductor of the wire is inserted into a hole in a PRINTED BOARD before soldering, the hole having a diameter slightly greater than that of the conductor, unless breakage close to the printed board is likely to occur as a result of vibration;
- e) the conductor of the wire and its insulation, if any, are securely wrapped around the termination by means of a special tool;
- f) the conductor of the wire and its insulation, if any, are crimped to the termination by means of an appropriate tool.

The methods under items a) up to and including f) apply to internal wires and the methods under items a) up to and including c) to external flexible cords.

In case of doubt, the vibration test of 3.2.8.1.3 is carried out to verify compliance.

3.6.3 Power supply cords

A power supply cord for connection to the a.c. **MAINS** shall be of the sheathed type and comply with the following, as appropriate:

- if rubber insulated, be of synthetic rubber and not lighter than ordinary tough rubber-sheathed flexible cord according to IEC 60245 (designation 245 IEC 60053);
- if PVC insulated:
 - for equipment provided with a **NON-DETACHABLE POWER SUPPLY CORD** and having a mass not exceeding 3 kg, be not lighter than light PVC sheathed flexible cord according to IEC 60227 (designation 227 IEC 60052);
 - for equipment provided with a **NON-DETACHABLE POWER SUPPLY CORD** and having a mass exceeding 3 kg, be not lighter than ordinary PVC sheathed flexible cord (designation 227 IEC 60053);
 - for equipment provided with a detachable power supply cord, be not lighter than light PVC sheathed flexible cord according to IEC 60227 (designation 227 IEC 60052).

NOTE

There is no limit on the mass of the equipment if the equipment is intended for use with a detachable power supply cord.

- include, for equipment required to have protective earthing, a protective earthing conductor having green-and-yellow insulation.

3.6.3.1 Test methodology

Compliance is checked by inspection.

In addition, for screened cords, compliance is checked by the tests of IEC 60227.

NOTE

Although screened cords are not covered in the scope of IEC 60227, the relevant tests of IEC 60227 are used.

3.6.3.2 Compliance criteria

The appropriate cord shall be used. For screened cords damage to the screen is acceptable provided that:

- during the flexing test the screen does not make contact with any conductor, and
- after the flexing test, the sample withstands the dielectric strength test between the screen and all other conductors.

3.7 Discharging of capacitors in primary circuits

Equipment shall be so designed that at an external point of the disconnection of the a.c. **MAINS**, there is no risk of electric shock from stored charge on capacitors connected to the a.c. **MAINS**.

3.7.1 Test methodology

Compliance is checked by inspection of the equipment and relevant circuit diagrams, taking into account the possibility of disconnection of the supply with the On/Off switch in either position.

Equipment is considered to comply if any capacitor, having a marked or nominal capacitance exceeding 0,1 μF and connected to **MAINS**, has a means of discharge resulting in a time-constant not exceeding:

- 2 s **PLUGGABLE EQUIPMENT TYPE A**;
- 10 s for **PERMANENTLY CONNECTED EQUIPMENT** and for **PLUGGABLE EQUIPMENT TYPE B**.

The relevant time-constant is the product of the effective capacitance in microfarad and the effective discharge resistance in megaohm. If it is difficult to determine the effective capacitance and resistance values, a measurement of voltage decay can be used.

3.7.2 Compliance criteria

During an interval equal to one time-constant, the voltage shall decay to a value below the voltage limit of **HAZARDOUS LIVE**.

3.8 Disconnect device

A **DISCONNECT DEVICE** in accordance with annex M shall be provided to disconnect the equipment from the supply for servicing.

Test methodology

Compliance is checked by inspection and by measuring the separation between the contacts of the **DISCONNECT DEVICE** in accordance with annex M.

4 Mechanical hazards

This clause covers the requirements for prevention of injuries relative to the nature of the mechanical hazards. This approach is reflected in the table below.

Table 4.1 - Mechanical hazards

Cause of hazard	Clause	Prevention/protection methods
Sharp edges and corners	4.1	<ul style="list-style-type: none"> Design without sharp edges and corners Restricting access Warning
Hazardous rotating or otherwise moving parts	4.2	<ul style="list-style-type: none"> Restrict/Prevent access SAFETY INTERLOCK systems DISCONNECT DEVICES Warning
Loosening, exploding or imploding parts	4.3	<ul style="list-style-type: none"> Shielding / Enclosing Design
Equipment instability	4.4	<ul style="list-style-type: none"> Stabilising means Design

4.1 Sharp edges and corners

The equipment shall be so designed that the risk of injury by sharp edges and corners is minimised. This can be achieved by deburring of edges and grinding of corners or by restricting access.

Where sharp edges are needed for functional purposes and access is unavoidable, guarding means shall be used to minimise the risk of unintentional contact with such edges.

If none of the prevention methods is practical, a clear warning shall be reliably affixed in a prominent position.

Test methodology

Compliance is checked by inspection and where applicable by the following test.

The guarding means is subjected to a steady force of $30\text{ N} \pm 3\text{ N}$ for a period of 5 s applied by means of the rigid test finger, test probe 11 of IEC 61032.

4.2 Hazardous rotating or otherwise moving parts

The equipment shall be so constructed that the risk of personal injury by moving or rotating parts is minimised.

In an **USER ACCESS AREA**, **MECHANICAL ENCLOSURES** and/or barriers shall have adequate mechanical strength and shall not be displaceable by hand.

MECHANICAL ENCLOSURES of moulded or formed thermoplastic materials shall be so constructed that any shrinkage or distortion of the material due to release of internal stresses caused by the moulding or forming operation does not result in the exposure of hazardous moving or rotating parts.

SAFETY INTERLOCKS shall be provided so that the hazard will be removed before access can be gained. Detailed requirements for **SAFETY INTERLOCKS** are given in annex L.

For a hazardous moving or rotating part which will continue to move or rotate through momentum, the removal, opening or withdrawal of a cover, door, etc. shall necessitate previous reduction of movement or rotation to a safe level.

DISCONNECT DEVICES shall be provided to stop rotating or moving parts where the possibility exists that fingers, jewellery, clothing, hair, etc. can be drawn into those parts (e.g. gears or shredder blades). Such

devices shall be placed in a prominent position and shall be accessible from the point where the risk of injury is highest. Detailed requirements for **DISCONNECT DEVICES** are given in annex M.

If none of the prevention methods are practicable, a clear warning shall be affixed in a prominent position.

Test methodology

Where access to hazardous rotating or moving parts is prevented by **MECHANICAL ENCLOSURES** and/or barriers, compliance is checked by:

- the examination of the construction and available data, or
- the tests of annex V as appropriate.

Upon completion of the tests, access to hazardous moving or rotating parts is checked with the rigid test finger, test probe 11 of IEC 61032, in every possible position.

Where **SAFETY INTERLOCKS** and/or **DISCONNECT DEVICES** are used, compliance is checked by inspection and by the tests in accordance with annex L and annex M respectively.

For warnings, if any, compliance is checked by visual inspection.

4.3 Loosening, exploding or imploding parts

Hazards described in this clause are:

- parts which may become loose, separated or thrown from a rotating or moving part;
A **MECHANICAL ENCLOSURE** shall be sufficiently complete to contain or deflect parts which, because of failure or for other reasons, might become loose, separated or thrown from a moving part.
- particles from an exploding part (e.g. high pressure lamp);
Protection shall be provided against particles from exploding parts by **MECHANICAL ENCLOSURES**.
In this standard, a high pressure lamp, a lamp in which the pressure exceeds a certain pressure limit (0,2 MPa when cold or 0,4 MPa when operating), is regarded as a potentially exploding part. A **MECHANICAL ENCLOSURE** of a high pressure lamp shall have adequate strength to contain all glass particles in the event of an explosion.
- particles from an imploding cathode ray tube (CRT).
Protection shall be provided against particles from an imploding CRT by design or by shielding.
Detailed requirements are given in annex W.

Test methodology

- For loosening parts, compliance is checked by visual inspection.
- High pressure lamps are tested in their lamp assembly or in the **MECHANICAL ENCLOSURE** of the equipment or both for the protection against the effects of the explosion by the following test:
An explosion of the lamp is stimulated by mechanical impact, circuit component failure or similar method.
- For CRTs having a maximum face dimension exceeding 160 mm compliance is checked by inspection, by measurement and by the tests of annex W.

4.4 Instability of equipment

The equipment shall not become physically unstable, i.e. overbalance, to a degree that it results in a hazard.

Where a means is provided to improve stability when drawers, doors, etc. are opened, it shall be permanently in operation when associated with **USER** use.

Where such means is not permanently provided but has to be used during service, warnings shall be provided for **SERVICE PERSONNEL**.

These requirements do not apply to:

- individual units which are designed to be mechanically fixed together on site and are not used individually, and

- equipment to be secured to the building structure before operation, in accordance with the installation instructions.

Test methodology

Compliance is checked by inspection and by the following tests, where relevant.

Each test is carried out separately. During the test, containers are to contain the amount of substance within their rated capacity producing the most disadvantageous condition. All castors and jacks, if used under **NORMAL OPERATING CONDITIONS**, are placed in their most unfavourable position, with wheels and the like locked or blocked.

a) Overbalance test (1)

This test is applied to units having a mass of 5 kg or more. The unit is tilted to an angle of 15° from its normal upright positions. Doors, drawers, etc. are closed during this test.

b) Overbalance test (2)

For floor standing units having a mass of 5 kg or more but less than 30 kg, a force equal to 20% of the weight of the unit but not more than 40 N, is applied in any horizontal direction at a height not exceeding 1,5 m from the floor.

Doors, drawers, etc. which may be moved are placed in their most unfavourable position, consistent with the manufacturer's instructions.

c) Overbalance test (3)

For floor standing units having a mass of 30 kg or more, a force equal to 20% of the weight of the unit but not more than 250 N, is applied in any direction except upwards at a height not exceeding 1,5 m from the floor.

Doors, drawers, etc. which may be moved are placed in their most unfavourable position, consistent with the manufacturer's instructions.

Compliance criteria

- Equipment having a mass of 5 kg to 30 kg shall pass the test of a) **or** b).
- Equipment exceeding a mass of 30 kg shall pass the test of a) **or** c).

The unit of equipment shall not overbalance.

5 Fire hazards

Fire hazards can affect people and the surrounding of the equipment.

The risk of starting a fire may result from excessive temperatures resulting from overloads, bridging of conductive parts, component failure, insulation breakdown, or loose connections, etc.

The probability for fires originating from within the equipment and spreading beyond the immediate vicinity of the source of fire, or causing damage to the surroundings of the equipment shall be minimised.

A simplified list of requirements related to protection against heat hazards is described in table 5.1. A detailed description is given in the following clauses.

Table 5.1 - Fire hazards

Cause of hazard	Clause	Prevention/protection methods
Start of fire under NORMAL OPERATING CONDITIONS	5.1	<ul style="list-style-type: none"> • Limit temperature of combustible materials • Limit possibility of bridging • Limit the possibilities of conductive parts entering the equipment
Start and spread of fire under abnormal operating conditions	5.2	<ul style="list-style-type: none"> • Limit start and spread of fire
Start of fire under abnormal operating conditions	5.3	<ul style="list-style-type: none"> • Limit temperatures of combustible material (Method 1)
Spread of fire under abnormal operating conditions	5.4	<ul style="list-style-type: none"> • Reduce the spread of fire (Method 2)
Overheating or bad connection of mains cord and mains wiring	5.5	<ul style="list-style-type: none"> • Use of correct mains cord • Use of proper cord anchorages • Correct use of terminals • Correct location of appliance inlets
Fire or explosion due to the presence of flammable liquids, gases, vapours, solids and a source of ignition	5.6	<ul style="list-style-type: none"> • Use alternate substances that are less flammable, • Isolate the flammable substances from sources of ignition, • Provide ventilation to reduce vapour concentration, • Provide warnings of possible hazards.

Figure 5.1 is a flowchart of the structure used in this clause.

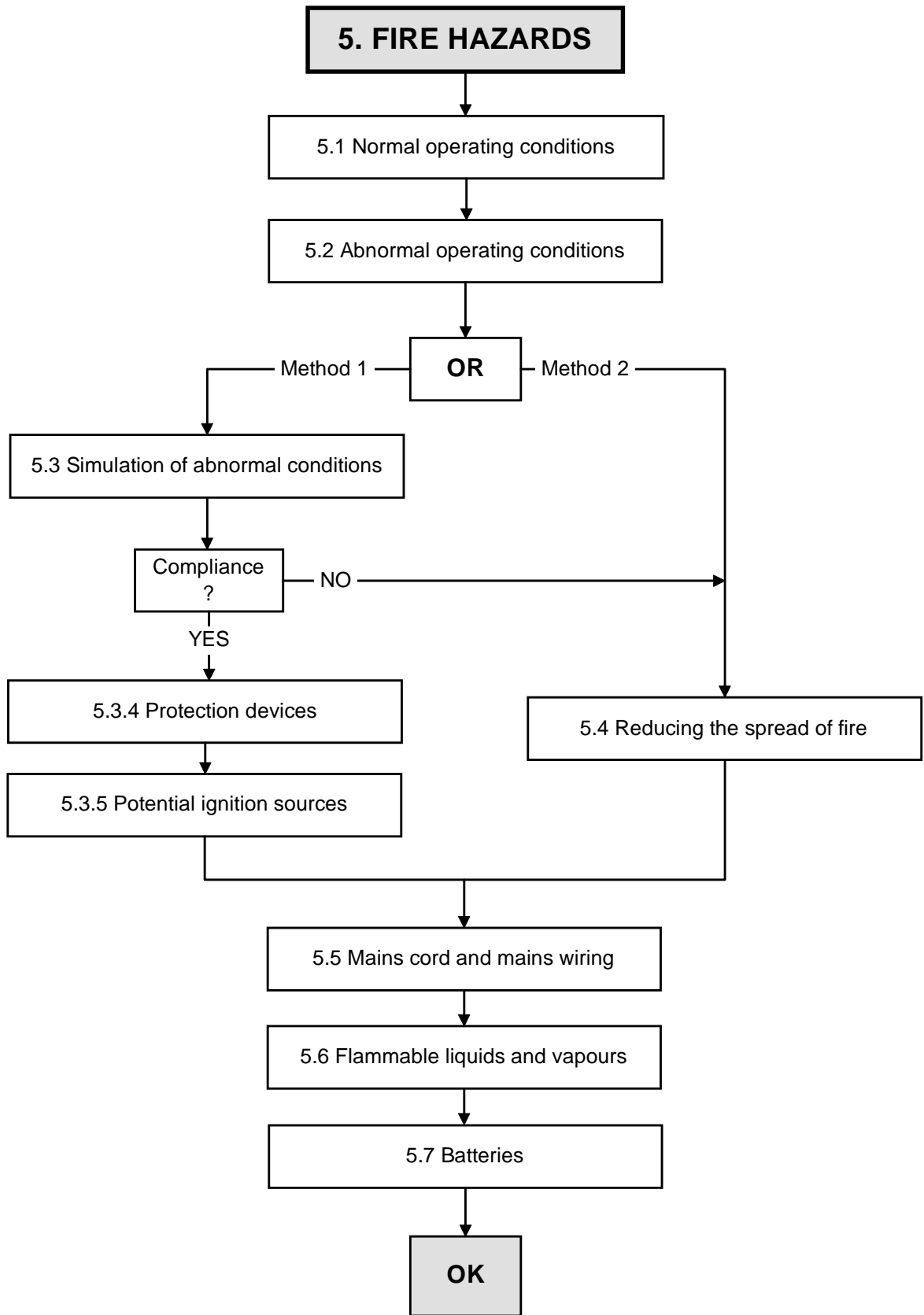

Figure 5.1 – Flow chart showing the structure of the heat hazard clause

5.1 Fire hazards under normal operating conditions

5.1.1 Requirements

- Under **NORMAL OPERATING CONDITIONS**, equipment and its components and parts shall not attain temperatures sufficient for ignition. Temperature specifications for components shall comply either with the requirements of this standard, or with the safety aspects of the relevant IEC component standards.
- Equipment shall be so designed that the risk of bridging of adjacent poles of circuits and components at **HAZARDOUS ENERGY LEVEL** by conducting objects is minimised.
- For **TRANSPORTABLE EQUIPMENT** the risk of ignition caused by small metallic objects moving around inside the equipment during transportation shall be reduced by means to minimise the likelihood of such objects entering the equipment and bridging adjacent poles of circuits or components at **HAZARDOUS ENERGY LEVEL**.

Acceptable measures include:

- providing openings that do not exceed 1 mm in width regardless of length; or
- providing openings with a screen having a mesh with nominal openings not greater than 2 mm between centre lines and constructed with a thread or wire diameter of not less than 0,45 mm; or
- providing internal barriers.

Additionally, where a metallized part of a plastic barrier or **ENCLOSURE** is within 13 mm of bare parts of circuits where the available power is greater than 15 VA, one of the following requirements applies:

- access by a foreign metallic object shall be limited in accordance with the above acceptable measures; or
- there shall be a barrier between the bare conductive parts and the **ENCLOSURE**.

NOTE

*Examples of metallized plastic **ENCLOSURES** include those made of conductive composite materials or that are electroplated, vacuum-deposited, painted or foil lined.*

- High voltage components and assemblies shall comply with annex G.6.
- Switches shall comply with annex G.1.

5.1.2 Test methodology

- Compliance of limiting temperatures is checked by inspection and by evaluation of the data of the materials and where appropriate by determining and recording the temperature of the various parts under **NORMAL OPERATING CONDITIONS**. (See annex B.5 and B.6).
- In order to verify that a part is accessible the jointed test finger and test pin, see test probe B and test probe 13 of IEC 61032 respectively, are applied without appreciable force, in any possible position. Equipment preventing the entry of the jointed test finger are further tested by means of a straight unjointed version of the test finger applied with a force of 30 N. If the unjointed test finger enters the equipment, the application of the jointed test finger is repeated, the test finger being pushed through the aperture. Compliance is checked by inspection that it will not be possible that conducting parts that may fall into the equipment can bridge circuits or components at a **HAZARDOUS ENERGY LEVEL**.

The test is repeated using the small finger probes 18 and 19 of IEC 61032. This does not apply if the intended conditions of use prevent the equipment from being accessed by children.

Openings in the top of enclosure are checked with the metal test pin of annex C.1. The test pin is suspended freely from one end and the penetration is limited to the length of the pin.

Floor standing equipment having a mass exceeding 40 kg is not tilted during the test.

- The compliance of transportable equipment is checked by inspection.
- The compliance of high voltage components and assemblies is checked as indicated in annex G.6.

- The compliance of switches is checked as indicated in annex G.1.

5.2 Limit start and spread of fire under abnormal operating conditions

For equipment or part of an equipment, there are two methods of providing sufficient protection against ignition and spread of flame under abnormal operating conditions.

Either one of the following methods may be used:

- Method 1 – Equipment is so designed that under abnormal operating conditions no part shall ignite. The appropriate requirements and tests are detailed in 5.3.
- Method 2 – Selection and application of components, wiring and materials which reduce the spread of flame and, where necessary, by the use of a **FIRE ENCLOSURE**. The appropriate requirements are detailed in 5.4.

Independent of the method used, high voltage components shall comply with the additional requirements of annex G.6.

5.3 Simulation of abnormal operating conditions (Method 1)

5.3.1 Requirements

Equipment shall be so designed that under abnormal operating conditions no part shall ignite.

5.3.2 Test methodology

The equipment is operated under abnormal operating conditions and the temperatures are measured after a steady state has been attained (but not later than after 4 hours). In the case where an applied fault condition results in interruption of the current before steady state has been reached, the temperatures are measured immediately after the interruption.

The conditions of annex B.8, which are possible causes for ignition, are applied in turn. A consequential fault may either interrupt or short-circuit a component. In case of doubt, the test shall be repeated up to two more times with replacement components in order to check that the same result is always obtained. Should this not be the case, the most unfavourable consequential fault shall be applied together with the specified fault.

If the temperature is limited by using a IEC 60127 fuse the temperature is measured as follows:

The fuse-link is short-circuited and the current passing through the fuse-link under the relevant fault condition, is measured.

If the fuse-link current remains less than 2,1 times the rated current of the fuse-link, the temperatures are measured after a steady state has been attained.

If the current is either immediately 2,1 times the rated current of the fuse-link or more, or reaches this value after a period of time equal to the maximum pre-arcing time for the current through the fuse-link, both the fuse-link and the short-circuit link are removed after an additional time corresponding to the maximum pre-arcing time of the fuse-link and the temperatures are measured immediately.

If the fuse resistance influences the current of the relevant circuit, the maximum resistance value of the fuse-link shall be taken into account when establishing the value of the current.

- **Exemption 1:** Circuits, or parts of a circuit supplied with an open circuit voltage not exceeding 35 V (peak) a.c. or d.c. and not generating voltages above that value, are not considered to present a fire hazard if the current which may be drawn from the supplying circuit for more than 2 min at any load, including short-circuit, is limited to 0,2 A. Such supplied circuits are not subject to fault conditions testing.
- **Exemption 2:** For components in **PRIMARY CIRCUITS** associated with the a.c. **MAINS**, such as the supply cord, appliance couplers, EMC filtering components, switches and their interconnecting wiring, no fault is simulated, provided that the component complies with the relevant IEC component standards and requirements of other parts of this standard, including **CLEARANCE** and **CREEPAGE DISTANCE** requirements.

5.3.3 Compliance criteria

Equipment complies with the requirements if:

- the temperature of components and parts is below the ignition temperature limit of the material used; or
- ignition occurs and does not sustain beyond 3 s.

If the failure of the insulation would not result in **HAZARDOUS LIVE** parts or **HAZARDOUS ENERGY LEVELS** becoming accessible, a maximum temperature of 300 °C is permitted for all materials, unless the ignition temperature is lower.

Higher temperatures are permitted for insulation made of glass or ceramic material.

If conductors on printed boards are interrupted, peeled or loosened during the test, the equipment is still deemed to be satisfactory if all of the following four conditions are met:

1. The printed board complies with flammability class V-1 or better;
2. The interrupted conductors have not peeled by more than 2 mm on each side;
3. The interruption is not a **POTENTIAL IGNITION SOURCE**;
4. The equipment complies with the requirements of this clause with the interrupted conductors bridged.

If the equipment does not fulfil the compliance criteria, the requirements of 5.4 apply.

5.3.4 Use of protection devices to limit heating under abnormal operation

If protection devices such as **THERMAL CUT-OUTS**, thermal links and PTC-resistors, are used to limit heating under abnormal operation, the requirements of G.2 to G.5 apply.

5.3.5 Separation from potential ignition sources

When the distance between a **POTENTIAL IGNITION SOURCE** and electrical components or mechanical parts does not exceed the values specified in table 5.3, these components and parts shall comply with the flammability requirements in table 5.3, unless shielded from **POTENTIAL IGNITION SOURCES** by a barrier made of metal or meeting the flammability category as specified in table 5.3. The barrier shall be solid and rigid and shall have dimensions covering at least the areas specified in table 5.3 and shown in annex T.

Printed boards carrying **POTENTIAL IGNITION SOURCES** are not considered to be a barrier for the purpose of this clause.

The requirement does not apply to any of the following:

- components and material inside a **FIRE ENCLOSURE** (see: 5.4.7);
- small mechanical parts, the mass of which does not exceed 4 g, such as mounting parts, gears, cams, belts and bearings;
- small electrical components, such as capacitors with a volume not exceeding 1750 mm³, integrated circuits, transistors and opto-coupler packages, if these components are mounted on material of flammability category V-1 or better according to IEC 60707;
- wiring, cable and connectors insulated with PVC, TFE, PTFE, FEP, neoprene or polyamide.

Base material of printed boards, on which the available power at a connection exceeds 15 W operating at a voltage exceeding 50 V and equal or less than 400 V (peak) a.c. or d.c. under **NORMAL OPERATING CONDITIONS**, shall be of flammability category V-1 or better according to IEC 60707, unless the printed boards are protected by an **ENCLOSURE** meeting the flammability category V-0 according to IEC 60707, or be made of metal, having openings only for connecting wires which fill the openings completely.

Base material of printed boards, on which the available power at a connection exceeds 15 W operating at a voltage exceeding 400 V (peak) a.c. or d.c. under **NORMAL OPERATING CONDITIONS**, and base material of printed boards supporting spark gaps which provide protection against overvoltages, shall be

of flammability category V-0 according to IEC 60707, unless the printed boards are contained in a metal **ENCLOSURE**, having openings only for connecting wires which fill the openings completely.

POTENTIAL IGNITION SOURCES with open circuit voltage exceeding 4 kV peak a.c. or d.c. under **NORMAL OPERATING CONDITIONS** shall be contained in a **FIRE ENCLOSURE** which shall comply with the flammability category V-1 or better according to IEC 60707, except that a **FIRE ENCLOSURE** is not required in case the open circuit voltage of the **POTENTIAL IGNITION SOURCE**:

- is limited to a value ≤ 4 kV by means of an electronic protective circuit; or
- does not exceed 4 kV at the moment the faulty connection interruption occurs.

Wood and wood-based material with a thickness of at least 6 mm is considered to fulfil the V-1 requirements of this clause. Otherwise the requirements of 5.4 apply.

Test methodology

Compliance is checked by inspection and measuring. The flammability categories are checked in accordance with IEC 60707 for the smallest thickness used, except for flammability category FH 3-40 mm/min, in which case the test is made on samples with a thickness of $3 \pm 0,2$ mm, irrespective of the actual thickness in the equipment.

For printed boards a preconditioning of 24 h at a temperature of 125 ± 2 C in an air circulating oven and a subsequent cooling period of 4 h at room temperature in a desiccator or over anhydrous calcium chloride is required.

Table 5.3 – Distances to potential ignition sources

Open circuit voltage of the POTENTIAL IGNITION SOURCE	Equipment containing voltages not exceeding 4 kV			Equipment containing voltages exceeding 4 kV				
	Distance from POTENTIAL IGNITION SOURCE to the component or part See annex T	Flammability category according to IEC 60707	Distance from POTENTIAL IGNITION SOURCE to barrier. Barrier flammability category, if other than metal	Distance from POTENTIAL IGNITION SOURCE to the component or part See annex T	Flammability category according to IEC 60707	Distance from POTENTIAL IGNITION SOURCE to barrier. Barrier flammability category, if other than metal		
	Downwards or sideways less than	Upwards less than		Downwards or sideways less than	Upwards less than			
> 50 V ≤ 400 V peak or d.c	13 mm	50 mm	FH 3-40 mm/min	13 mm	50 mm	V-1	≥ 5 mm V-1	
> 400 V $\leq 4\ 000$ V peak or d.c	13 mm	50 mm	V-1	≥ 5 mm V-1	20 mm	50 mm	V-1	≥ 5 mm V-0

5.4 Reduce the spread of fire (Method 2)

A **FIRE ENCLOSURE** is required when during abnormal conditions temperatures of parts could be sufficient for ignition.

Equipment shall be designed such that the **FIRE ENCLOSURE** will minimise the risk of a fire spreading to the outside of the equipment. It shall also minimise the possibility of emission of flame, molten metal, flaming or glowing particles or flaming drops.

5.4.1 Parts requiring a fire enclosure

Except where method of 5.3 (simulation of abnormal conditions) is used exclusively, or as permitted in 5.4.2 the following parts have a risk of ignition and require a **FIRE ENCLOSURE**:

- components in **PRIMARY CIRCUITS**;
- components within a power supply unit or assembly having a limited power output as specified in annex S, including overcurrent protective devices, limiting impedances, regulating networks and wiring, up to the point where the limited power source output criteria are met;
- components in **SECONDARY CIRCUITS** supplied by a power source which exceeds the limits of a limited power source as specified in annex S under **NORMAL OPERATING CONDITIONS** or under abnormal operating conditions;
- components in **SECONDARY CIRCUITS** supplied by a limited power source as specified in annex S but not mounted on material of flammability category V-1 or better;
- components having unenclosed arcing parts, such as open switch and relay contacts in a **HAZARDOUS LIVE** circuit or in a circuit at **HAZARDOUS ENERGY LEVEL**;
- insulated wiring, except when insulated with PVC, TFE, PTFE, PEP, neoprene or polyamide.

NOTE

Reference is made to ISO 1043-1 for the meaning of the abbreviations.

5.4.2 Parts not requiring a fire enclosure

The following parts do not require a **FIRE ENCLOSURE**:

- components, including connectors, which fill an opening in a **FIRE ENCLOSURE** and which are of flammability category V-1 or comply with the flammability requirements of the relevant IEC component standard;
- connectors in **SECONDARY CIRCUITS** supplied by power sources which are limited to a maximum of 15 VA under **NORMAL OPERATING CONDITIONS** and under abnormal operating conditions;
- plugs and connectors forming part of a power supply cord or interconnecting cable;
- connectors in **SECONDARY CIRCUITS** supplied by limited power source complying with annex S;
- other components in **SECONDARY CIRCUITS** supplied by limited power sources complying with annex S, provided they are mounted on material of flammability category V-1 or better;
- wiring insulated with PVC, TFE, PTFE, PEP, neoprene or polyamide;
- other components in **SECONDARY CIRCUITS** supplied by internal or external power sources which are limited to a maximum of 15 VA under **NORMAL OPERATING CONDITIONS** and under abnormal operating conditions and mounted on material of flammability category HB 75;
- motors complying with annex J;
- transformers complying with annex H

Test methodology

Compliance with 5.4.1 and 5.4.2 is checked by inspection and by evaluation of the data provided by the manufacturer. For determining the risk of ignition in cases not specified in 5.4, compliance is checked by method 1 in 5.3.

5.4.3 Materials for fire enclosure

- For movable equipment having a total mass not exceeding 18 kg, the material of a **FIRE ENCLOSURE**, in the smallest thickness used, shall be of flammability category V-1 or better, or pass the test of annex U.2.
- For movable equipment having a total mass exceeding 18 kg and for all **STATIONARY** equipment, the material of a **FIRE ENCLOSURE**, in the smallest thickness used, shall be of flammability category 5V or better, or pass the test of annex U.1.
- Components which fill an aperture in a **FIRE ENCLOSURE**, shall be of flammability category V-1 or comply with the flammability requirements of the relevant IEC component standard, or pass the test of annex U.2.

- Wood and wood-based material with a thickness of at least 6 mm is considered to fulfil the V-1 requirements of this clause.

Test methodology

Compliance is checked by inspection and where applicable by flammability tests of annex U.

5.4.4 Top and side openings in fire enclosures

Openings for ventilation etc. shall be protected by a baffle, screen or the like so that flames and fuel cannot get out of the fire enclosure.

For equipment that is intended to be used in more than one orientation, the requirements of 5.4.4 and 5.4.5 apply in each appropriate orientation.

Test methodology

Compliance is checked by inspection.

5.4.5 Bottoms of fire enclosures

The bottom of a **FIRE ENCLOSURE** or individual barriers shall provide protection under all internal parts, which, under fault conditions, could emit material likely to ignite the supporting surface.

The following constructions are considered to satisfy the requirement without test:

- no opening in the bottom of a **FIRE ENCLOSURE**;
- openings in the bottom of any size under an internal barrier, which itself complies with the requirements for a **FIRE ENCLOSURE**;
- openings in the bottom, each not larger than 40 mm², under components and parts meeting the requirements for flammability class V-1 or HF-1;
- baffle plate construction as illustrated in figure 5.2;
- metal bottoms of **FIRE ENCLOSURES** confirming with the dimensional limits of any line in table 5.4;
- metal bottom screen having a mesh with nominal openings not greater than 2 mm between centre lines and with wire diameters not less than 0,45 mm.

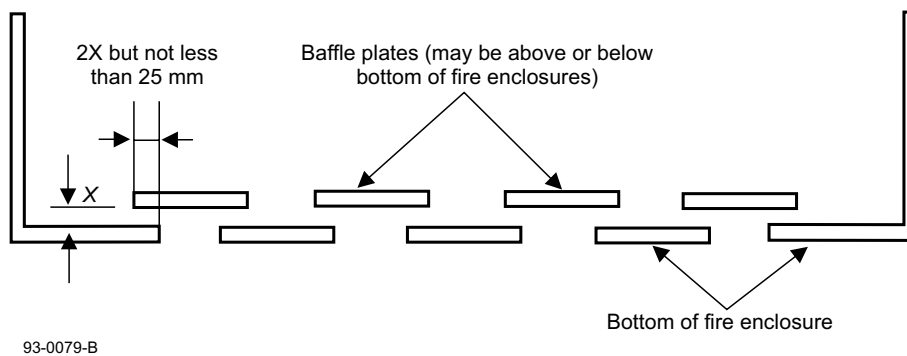

Figure 5.2 - Baffle plate construction

Table 5.4 - Size and spacing of holes in metal bottoms of fire enclosures

Metal bottom minimum thickness	Circular holes		Other shaped openings	
	Maximum diameter of holes	Minimum spacing of holes centre to centre	Maximum area	Minimum spacing of openings border to border
0,66 mm	1,14 mm	1,70 mm	1,1 mm ²	0,56 mm
0,66 mm	1,19 mm	2,36 mm	1,2 mm ²	1,1 mm
0,76 mm	1,15 mm	1,70 mm	1,1 mm ²	0,55 mm
0,76 mm	1,19 mm	2,36 mm	1,2 mm ²	1,1 mm
0,81 mm	1,91 mm	3,18 mm	2,9 mm ²	1,1 mm
0,89 mm	1,90 mm	3,18 mm	2,9 mm ²	1,2 mm
0,91 mm	1,60 mm	2,77 mm	2,1 mm ²	1,1 mm
0,91 mm	1,98 mm	3,18 mm	3,1 mm ²	1,2 mm
1,00 mm	1,60 mm	2,77 mm	2,1 mm ²	1,1 mm
1,00 mm	2,00 mm	3,00 mm	3,2 mm ²	1,0 mm

Test methodology

Compliance is checked by inspection and where applicable by flammability tests of annex U.3.

5.4.6 Doors or covers in fire enclosures

If part of a **FIRE ENCLOSURE** consists of a door or cover leading to an **USER ACCESS AREA**, the door or cover shall comply with one of the following three requirements:

- a) the door or cover shall be interlocked and comply with the interlock requirements in annex L; or
- b) a door or cover, intended to be routinely opened by the user, shall comply with both of the following conditions:
 - it shall not be removable from other parts of the **FIRE ENCLOSURE** by the **USER**; and
 - it shall be provided with a means to keep it closed during normal operation; or
- c) a door or cover intended only for occasional use by the **USER**, such as for the installation of accessories, is permitted to be removable provided that the equipment instructions include directions for correct removal and reinstallation of the door or cover.

Test methodology

Compliance is checked by inspection.

5.4.7 Materials for components and parts inside fire enclosure

Inside **FIRE ENCLOSURES**, materials for components and other parts (including **MECHANICAL ENCLOSURES** and **ELECTRICAL ENCLOSURES** located inside **FIRE ENCLOSURE**), shall be of flammability category V-2 or HF-2, or pass the flammability test of annex U.2, or shall meet the flammability requirements of a relevant IEC component standard which includes such requirements.

The requirement above does not apply to any of the following:

- materials and components within an enclosure of 0,06 m³ or less, consisting totally of metal and having no ventilation openings, or within a sealed unit containing inert gas;
- one or more layers of thin insulating material, such as adhesive tape, used directly on any surface within **FIRE ENCLOSURE** provided that the combination of the thin insulating material and the surface complies with the requirements of flammability category V-2 or HF-2;
- meter cases, meter faces and indicator lamps or jewels;
- electronic components, such as integrated circuits packages, opto-coupler packages, capacitors and other small parts that are mounted on material of flammability class V-1;

- wiring, cables and connectors insulated with PVC, TFE, PTFE, FEP, neoprene and polyamide;
- for wiring harnesses, individual clamps (not continuous forms), lacing tape, twine and cable ties;
- the following parts, provided that they are separated from electrical parts (other than insulated wires and cables), which under fault conditions are likely to produce a temperature that could cause ignition, by at least 13 mm of air or by a solid barrier of material of flammability class V-1 or better:
 - gears, cams, belts, bearings and other small parts which would contribute negligible fuel to a fire, including labels, mounting feet, knobs and the like;
 - supplies, consumable materials, media and recording materials;
 - parts, which are required to have particular properties in order to perform intended functions, such as rubber rollers for paper pick-up and delivery, and ink tubes;
 - tubing for air or any fluid system, containers for powders or liquids and foamed plastic parts, provided that they are of flammability class HB 40 or FH 3.

Test methodology

Compliance is checked by inspection and where relevant by flammability tests of annex U.

5.5 Mains cord and mains wiring

For safe connection to the a.c. **MAINS**, equipment shall be provided with one of the following:

- terminals for permanent connection to the supply;
- a **NON-DETACHABLE POWER SUPPLY CORD** for permanent connection to the supply, or for connection to the supply by means of a plug;
- an appliance inlet for connection of a detachable power supply cord;
- a **MAINS** plug that is part of direct plug-in equipment.

5.5.1 Mains supply cords

MAINS supply cords shall be of the sheathed type complying with IEC 60227 for PVC insulated cords or according to IEC 60245 for rubber insulated cords.

MAINS supply cords shall have conductors with cross-sectional areas not less than those specified in table 5.5.

Table 5.5 - Sizes of conductors in mains supply cords

Rated current consumption of the equipment ¹⁾	Nominal cross-sectional area
≤ 3 A	0,5 mm ² ²⁾
> 3 A ≤ 6 A	0,75 mm ²
> 6 A ≤ 10 A	1,00 mm ² (0,75 mm ²) ³⁾
> 10 A ≤ 13 A	1,25 mm ² (1,0 mm ²) ⁴⁾
> 13 A ≤ 16 A	1,5 mm ² (1,0 mm ²) ⁴⁾
> 16 A ≤ 25 A	2,5 mm ²
> 25 A ≤ 32 A	4 mm ²
> 32 A ≤ 40 A	6 mm ²
> 40 A ≤ 63 A	10 mm ²
> 63 A ≤ 80 A	16 mm ²
> 80 A ≤ 100 A	25 mm ²
> 100 A ≤ 125 A	35 mm ²
> 125 A ≤ 160 A	50 mm ²

1) The **RATED CURRENT** consumption includes currents which can be drawn from the socket-outlet providing **MAINS** power for other equipment.

2) This nominal cross-sectional area is allowed only for **CLASS II** equipment and provided that the length of the supply cord, measured between the point where the cord, or the cord guard, enters the equipment, and the entry to the plug, does not exceed 2 m.

3) The value in parentheses applies to detachable power supply cords fitted with the connectors rated 10 A in accordance with IEC 60320 (types C13, C15, C15A and C17), provided that the length of the cord does not exceed 2 m.

4) The value in parentheses applies to detachable power supply cords fitted with the connectors rated 16 A in accordance with IEC 60320 (types C19, C21 and C23), provided that the length of the cord does not exceed 2 m.

NOTE
IEC 60320 specifies acceptable combinations of appliance couplers and flexible cords, including those covered by conditions 1), 2) and 3). However, a number of countries have indicated that they do not accept all of the values listed in Table 11, particularly those covered by conditions 2), 3) and 4).

Test methodology

Compliance is checked by inspection

5.5.2 Cord anchorages

For equipment with a **NON-DETACHABLE POWER SUPPLY CORD**, a cord anchorage shall be supplied such that the connecting points of the cord conductors are relieved from strain and the outer covering of the cord is protected from abrasion.

The cord anchorage shall either be made of insulating material or have a lining of insulating material. The construction of the cord anchorage shall be such that:

- it shall not also be possible to push the cord back into the equipment if this impairs safety; and
- cord replacement does not impair the safety of the equipment; and
- the method by which the relief from strain and the prevention of twisting is provided, is clearly seen; and
- the cord is not clamped by a screw which bears directly on the cord; and
- methods such as tying the cord into a knot or tying the cord with a string are not used; and

- the cord cannot rotate in relation to the body of the equipment to such an extent that mechanical strain is imposed on the electrical connections.

Test methodology

Compliance is checked by inspection and by applying the following tests:

- a mark is made on the cord, under strain, near the aperture;
- the cord is subjected to a steady pull of 40 N, applied in the most unfavourable direction. The test is conducted 25 times, each time for 1 s;
- immediately afterwards the cord is subjected for 1 min to a torque of 0,25 Nm;
- the cord displacement is measured while the cord is still under strain of 40 N.

During the test the power supply cord shall not be damaged. This is checked by visual inspection, and by a dielectric strength test between the power cord conductors and accessible conductive parts, at the test voltage appropriate for **REINFORCED INSULATION**.

Compliance criteria

After the test the power supply cord shall not have been longitudinally displaced by more than 2 mm nor shall there be appreciable strain at the connections.

5.5.3 Terminals for mains cord

PERMANENTLY CONNECTED equipment and equipment with ordinary **NON-DETACHABLE POWER SUPPLY CORDS** shall be provided with terminals in which connection is made by means of screws, nuts or equally effective devices. Conductors connected by soldering are not considered to be adequately fixed unless they are held in place independently of the solder.

Compliance is checked by inspection, and in case of doubt, by applying a pull of 5 N in any direction to the connection.

Screws and nuts which clamp external power supply conductors shall have a thread conforming with ISO 261 or ISO 262, or a thread comparable in pitch and mechanical strength. The screws and nuts shall not serve to fix any other component, except that they are permitted also to clamp internal conductors provided that the internal conductors are so arranged that they are unlikely to be displaced when fitting the supply conductors.

Terminals shall allow the connection of conductors having nominal cross-section area as shown in table 5.5.

The end of a stranded conductor shall not be consolidated by soft soldering at places where the conductor is subject to contact pressure unless the method of clamping is designed so as to reduce the likelihood of a bad contact due to cold flow of the solder. Spring terminals that compensate for the cold flow are deemed to satisfy this requirement. Preventing the clamping screws from rotating is not considered to be adequate.

Test methodology

Compliance is checked by inspection

5.5.4 Appliance inlet supplied with the equipment for connection of detachable power supply cord

Appliance inlets shall be so located that after insertion of the connector, which is intended to be used with the equipment, the equipment is not supported by the connector for any position of normal use on a flat surface.

Test methodology

Compliance is checked by inspection

5.6 Flammable liquids and vapours

Equipment in which flammable liquids, flammable gases, or similar hazards are present, shall be so designed that harmful effects to persons and damage to materials affecting safety are minimised.

If a flammable liquid is used in equipment, the liquid shall be kept in a closed reservoir, except for the amount needed for the functioning of the equipment. The maximum quantity of flammable liquid stored in an equipment shall in general be not more than 5 l. If, however, the usage of liquid is such that more than

5 l is consumed in 8 h, the quantity stored is permitted to be increased to that required for an 8 h operation.

Oil or equivalent fluids used for lubrication or in a hydraulic system shall have a flash point of 149°C or higher, and the reservoir shall be of sealed construction. The system shall have provision for expansion of the fluid and shall incorporate means for pressure relief. This requirement is not applicable to lubricating oils which are applied to points of friction in quantities which would contribute negligible fuel to a fire.

Except under conditions given below, replenishable liquids such as printing inks shall have a flash point of 60°C or higher, and shall not be under sufficient pressure to cause atomisation.

Replenishable flammable liquids which have a flash point of less than 60°C or which are under sufficient pressure to cause atomisation are permitted provided inspection shows that there is no likelihood of liquid sprays or build-up of flammable vapor-air mixtures which could cause explosion or fire hazard. Under **NORMAL OPERATING CONDITIONS**, equipment using a flammable liquid shall not generate a mixture with a concentration exceeding one quarter of the explosion limit if the mixture is in proximity to an ignition source, or exceeding half the explosion limit if the mixture is not in proximity to an ignition source. The investigation shall also take into account the integrity of the liquid handling system. The liquid handling system shall be suitably housed or constructed so as to avoid the risk of fire or explosion, even under the test conditions specified in V.2.

User, service, and installation manuals shall provide warnings concerning the selection and flash point of flammable liquids.

Test methodology

Compliance is checked by inspection and, where necessary, by the following test:

- The equipment is operated in accordance with B.4 until its temperature stabilizes. Samples of the atmosphere in the vicinity of the electrical components and around the equipment are taken to determine the concentration of flammable vapors present.
- Samples of the atmosphere are taken at 4 min intervals: four samples to be taken during normal operation, then seven samples after the equipment has stopped.
- If, after the equipment has stopped, the concentration of flammable vapors appears to be increasing, samples shall continue to be taken at 4 min intervals until the concentration is shown to be decreasing.

If operation of the equipment is possible with any of its fans not running, this condition is simulated during this compliance test.

Compliance criteria

The vapour-air concentrations do not exceed the specified limits.

5.7 Batteries

The risk of fire associated with the use of batteries in equipment is evaluated according to annex N.

6 Burn Hazards

Burns hazards or undesirable reactions may result from high temperatures on accessible surfaces. These could affect the **USER** or **SERVICE PERSONNEL**.

A simplified list of requirements related to protection against heat hazards is described in table 6.1. A detailed description is given in the following clauses.

Table 6.1 - Protection against burn hazards.

Cause of hazard	Clause	Prevention/protection methods
Access to hot surfaces in USER ACCESS AREA	6.1	<ul style="list-style-type: none"> • Temperature limits for accessible surfaces • Provide warning if high temperature is unavoidable for functional reason or due to high ambient temperature
Access to hot surfaces in SERVICE ACCESS AREA		<ul style="list-style-type: none"> • Temperature limits for any surface which can be inadvertently touched • Hot surfaces shall be identifiable as being hot or be identified by a warning

6.1 Requirements

- Equipment shall be so designed, that temperatures of accessible hot surfaces in **USER ACCESS AREA** are limited to the temperatures as shown in table 6.2.
- Where the limits of table 6.2 are exceeded for functional reasons or due to ambient temperatures above 40 °C, warning according to IEC 60417, 604051 shall be provided. It shall be clear, located in a prominent position and be reliably affixed. Handheld equipment with a non-metallic surface shall not require the warning label.
- Equipment shall be so designed that any surface which can be inadvertently touched in a **SERVICE ACCESS AREA** shall meet the temperature limits of table 6.2.
- Surfaces exceeding the temperature limits of table 6.2 shall, by their shape or function, be identifiable as being hot, or be identified by a warning.
- Equipment shall be so designed that the risk of bridging of adjacent poles of circuits and components at **HAZARDOUS ENERGY LEVELS** by means of metallic objects such as rings, bracelet, tools, etc is minimised. In **SERVICE ACCESS AREAS** where this is not practical for functional reasons an appropriate warning shall be included in the service documentation.

Table 6.2 - Temperature limits

Part	Contact period	Material	Temperature
handles, knobs, grips, etc.	continuously held	all	43 °C
	held or touched for short periods only	metallic	55 °C
external surface of equipment	may be touched	non-metallic	65 °C
		metallic	65 °C
<p>NOTE 1</p> <ul style="list-style-type: none"> • Continuous holding is assumed to be below 8 hours. Less than 10 % of the entire skin surface of body is assumed to touch the hot surface. Limit temperature derived from EN 60563. • Short period holding is assumed to be below 10 s. • “May be touched” contact time is assumed to be below 1 s. <p>NOTE 2</p> <p>For outside parts of metal which are covered by plastic material, the thickness of which is at least 0,3 mm, a temperature which corresponds to the permissible temperature of the non-metallic material is allowed.</p> <p>NOTE 3</p> <p>For heat sinks, ENCLOSURES directly covering a heat sink, or areas on the external surface of equipment and having no dimension exceeding 50 mm and which are not likely to be touched in normal use, temperatures up to 100 °C are permitted.</p>			

6.2 Test Methodology

Compliance is checked by inspection and where appropriate, by measuring the temperature of accessible surfaces in accordance with the conditions in annex B.5.

The equipment is operated under **NORMAL OPERATING CONDITIONS** and abnormal operating conditions and the temperatures are measured after a steady state has been attained, but not later than after 4 hours.

In deciding whether or not inadvertent contact or bridging is likely, account is taken of the way **SERVICE PERSONNEL** need to gain access to parts, or near to parts in order to service other parts.

For warnings compliance with requirements is checked by inspection.

7 Chemical hazards

Consumable materials necessary for the operation of products may present potential chemical hazards. Hazards may arise from the inhalation of vapors or fumes, from ingestion of these substances, or from physical contact with these materials. Products that generate high voltage may produce ozone. It is essential to

- determine what substances are present;
- understand what potential hazards their use may present and;
- minimize the risk of a hazard to **USERS** and **SERVICE PERSONNEL** due to interacting with these materials.

In addition to their potential toxicity, loss of containment of chemical consumables may cause or contribute to other hazards such as:

- fire;
- electric shock;
- personal injury due to slippery surfaces.

Table 7.1 - Chemical hazards

Cause of hazard	Clause	Prevention/protection methods
Ingestion, inhalation, skin contact, or other exposure to potentially hazardous chemicals	7.1	<ul style="list-style-type: none"> • Where possible, avoid the use of potentially hazardous chemicals. • Minimize accessibility by providing guarding, ventilation, or containment. • Provide warnings. • Minimize emissions.
Exposure to excessive concentrations of ozone	7.2	<ul style="list-style-type: none"> • Where possible, minimize the use of functions that produce ozone. • Provide adequate room ventilation. • Provide filtration to remove ozone.
Explosion due to an explosive mixture of fine particles suspended in air and the presence of a source of ignition	7.3	<ul style="list-style-type: none"> • Reduce the presence of fine particles available for suspension in air. • Avoid the use of air movement near sources of fine particles. • Warn against the possible hazards of using common vacuum cleaners for picking up spills. • Isolate sources of ignition.

7.1 Hazardous chemicals

Equipment using consumable materials shall be so constructed that exposure to **USERS** and **SERVICE PERSONNEL** of chemicals which are hazardous to health, their vapours, or emissions is minimised or eliminated.

Where potentially hazardous fumes or vapors are generated during the normal operation of the equipment, adequate ventilation shall be provided to reduce their concentration to a level not exceeding the recommended threshold value for any of the hazardous substances in the fumes.

NOTE

Recommended threshold values may vary from country to country.

Contact with hazardous materials shall be minimised by the use of guards, **MECHANICAL ENCLOSURES**, or containers which reduce the need for handling.

The above mentioned consumables shall be identified in the installation, operating, and service manuals. These manuals shall contain instructions for the safe handling, storage and disposal of the materials.

NOTE

Some countries may have regulations governing the storage and disposal of hazardous materials.

Test methodology

Compliance is checked by inspection.

Barriers, guards or **MECHANICAL ENCLOSURES** used to minimise access to materials are evaluated by:

- the examination of the construction and available data, or
- the test of annex V.1.

7.2 Ozone

For equipment that may produce ozone, the installation and operating instructions shall refer to the need to provide adequate room ventilation or adequate filtering to ensure that the concentration of ozone resulting from the equipment operation is kept below applicable exposure limits.

When filters are used maintenance instructions shall be provided.

NOTE

The present recommended long term exposure limit for ozone is 0.1 ppm (0.2 mg/m³) calculated as an 8 hour time-weighted average concentration. It should be noted that ozone is heavier than air.

Test Methodology

Compliance is checked by inspection and, where necessary, by the test method of ECMA TR/56.

7.3 Dust, particulates, liquids, or gases

Equipment producing dust (e.g., paper dust) or employing powders, liquids, or gases shall be constructed such that no concentration of these materials can exist which create a hazard within the meaning of this standard (e.g. by movement, condensation, vaporization, leakage, spillage, or corrosion during normal operation, storage, filling or emptying).

If equipment uses or generates fine powders or particulates and the possibility exists that an **USER** or **SERVICE PERSONNEL** may attempt to clean up spills with an electric vacuum cleaner, appropriate instructions and warnings shall be provided if the use of an unsuitable device could result in a potential dust-air explosion hazard.

Test methodology

Compliance is checked by inspection of the equipment and of the installation, user, and service instructions for handling and disposal of the consumable materials.

Where spillage of liquid during replenishment could affect electrical insulation, compliance is checked by inspection and by the following test, and for flammable liquids, by the tests of 5.2.6.

The equipment shall be ready to use according to its installation instructions, but not energised.

The liquid container of the equipment is completely filled with the liquid specified by the manufacturer and a further quantity, equal to 15% of the capacity of the container is poured in steadily over a period of 1 min. For liquid containers having a capacity not exceeding 250 ml, and for containers without drainage and for which the filling cannot be observed from outside, a further quantity of liquid, equal to the capacity of the container, is poured in steadily over a period of 1 min.

Immediately after this treatment, the equipment shall withstand an electric strength test as specified in 3.2.3.1.3 on any insulation on which spillage could have occurred.

Compliance criteria

The excess liquid does not create a hazard either by reducing the integrity of electrical insulation, as demonstrated by the results of electric strength tests, or by spilling out onto the floor or supporting surface where it could cause a slip or fall for people near the equipment.

8 Radiation

Table 8.1 - Protection against radiation hazards.

Cause of hazard	Clause	Prevention/protection methods
Laser radiation	8.1	<ul style="list-style-type: none">ensure optical design
Ionising radiation	8.2	<ul style="list-style-type: none">limit radiation

8.1 Laser radiation

Equipment containing a laser system shall be so constructed that personal protection against laser radiation is provided under **NORMAL OPERATING CONDITIONS** and under abnormal operating conditions.

LEDs shall meet the same requirements.

Test methodology

For equipment using lasers, compliance is checked according to IEC 60825-1 and IEC 60825-2 where appropriate.

8.2 Ionising radiation

Equipment that can generate ionising radiation shall be so designed that harmful effects to persons and damage to materials affecting safety are prevented.

At any point 10 cm from the surface of the **USER ACCESS AREA**, the dose-rate shall not exceed 1 $\mu\text{S/hr}$. Account is taken of the background level.

Test methodology

Equipment which might produce ionising radiation is checked by measuring the amount of radiation.

The amount of radiation is determined by means of a radiation monitor of the ionising chamber type with an effective area of 10 cm^2 , or by measuring equipment of other types giving equivalent results.

Measurements are made with the equipment under test operating at the most unfavourable supply voltage (see D.4.2) and with **USER** controls and service controls adjusted so as to give maximum radiation whilst maintaining **NORMAL OPERATING CONDITIONS**.

Internal pre-set controls not intended to be adjusted during the lifetime of the equipment are not considered to be service controls.

Annexes

A	(informative)	Examples of equipment within the scope of this Standard
B	(normative)	General conditions for tests
C	(normative)	Test probe
D	(normative)	Test generators
E	(normative)	Measuring network for touch currents
F	(normative)	Marking and instructions
G	(normative)	Components
H	(normative)	Transformers
J	(normative)	Motor tests under abnormal conditions
K	(normative)	Insulated winding wires for use without interleaved insulation
L	(normative)	Safety interlocks
M	(normative)	Disconnect devices
N	(normative)	Batteries
P	(normative)	Table of electrochemical potentials
Q	(normative)	Measurement of creepage distances and clearances
R	(normative)	Alternative method for determining minimum clearances
S	(normative)	Limiting the available current and energy
T	(normative)	Distance from potential ignition sources
U	(normative)	Tests for resistance to heat and fire
V	(normative)	Tests for enclosures
W	(normative)	Mechanical strength of CRTs and protection against the effects of implosion

Annex A

(informative)

Examples of equipment within the scope of this Standard

Some examples of equipment within the scope of this Standard are:

Office equipment

Calculators, cash registers, copying machines, data and text processing equipment, data preparation equipment, dictation equipment, document shredding machines, duplicators, electrically operated drawing machines (plotters), erasers, facsimile equipment, magnetic tape handlers, mail processing machines, micrographic office equipment, monetary processing machines, motor-operated files, personal computers, point of sale terminals, postage machines, staplers, telephone answering machines, typewriters, visual display units.

Consumer electronic equipment

Antenna positioners, antenna signal converters and amplifiers, apparatus for imagery, audio and/or video equipment, electronic gaming and scoring machines, electronic musical instruments and electronic accessories such as rhythm generators, flipper games, independent load transducers and source transducers, juke boxes, light effect apparatus, music tuners and the like for use with electronic or non-electronic musical instruments, receiving apparatus and amplifiers for sound and/or vision, record and optical disc players, self-contained tone generators, tape and optical disc recorders, teletext equipment, video cameras and video monitors, video games, video projectors.

Telecommunication terminal equipment

Data circuit terminating equipment (e.g. modems), data terminal equipment, intercommunication apparatus using low voltage mains as the transmission medium, key telephone systems, PABXs.

This list is not intended to be comprehensive, and equipment that is not listed is not necessarily excluded from the scope.

Annex B

(normative) General conditions for tests

B.1 Applicability of requirements

The requirements and tests detailed in this standard shall be applied only if safety is involved. If it is evident that a particular test is not applicable, the test shall not be made.

In order to establish whether or not safety is involved, the circuits and construction shall be carefully investigated to take into account the consequences of possible failures.

B.2 Type of tests

Except where otherwise stated, tests specified in this standard are type tests.

B.3 Test samples

Unless otherwise specified, the sample under test shall be representative of the equipment the user would receive, or shall be the actual equipment ready for shipment to the user.

As an alternative to carrying out tests on the complete equipment, tests may be carried out separately on circuits, components or sub-assemblies outside the equipment, provided that inspection of the equipment and circuit arrangements ensures that such testing will indicate that the assembled equipment would conform to the requirements of the standard. If any such test indicates the likelihood of non conformance in the complete equipment, the test shall be repeated in the equipment.

If a test specified in this standard could be destructive, it is permitted to use a model to represent the condition to be evaluated.

NOTE

In view of the amount of resource involved in testing and in order to minimise waste, it is recommended that all parties concerned jointly consider the test programme, the test samples and the test sequence. Tests which may result in the destruction of the sample are recommended to be carried out last.

B.4 Conditions for tests

B.4.1 General

Except where specific test conditions are stated elsewhere in the standard and, where it is clear that there is a significant impact on the results of the test, the tests shall be carried out under the most unfavourable combination within the manufacturer's operating specifications of the following parameters:

- supply voltage,
- supply frequency,
- physical location of equipment and position of movable parts,
- operating mode,
- adjustment of THERMOSTATS, regulating devices or similar controls in **USER ACCESS AREAS**, which are:
 - adjustable without the use of a **TOOL**, or
 - adjustable using a means, such as a key or a **TOOL**, deliberately provided for the USER.

B.4.2 Supply voltage

In determining the most unfavourable supply voltage for a test, the following variables shall be taken into account:

- multiple **RATED VOLTAGES**,
- extremes of **RATED VOLTAGE**,

- tolerance on **RATED VOLTAGE** as declared by the manufacturer.

If no tolerance is declared by the manufacturer, it shall be taken as +10% and -10%.

When testing equipment designed for d.c. only, the possible influence of polarity shall be taken into account.

B.4.3 Supply frequency

In determining the most unfavourable supply frequency for a test, different **RATED FREQUENCIES** within the **RATED FREQUENCY** range shall be taken into account (e.g. 50 Hz and 60 Hz) but consideration of the tolerance on a **RATED FREQUENCY** (e.g. 50 Hz \pm 0,5 Hz) is not necessary.

B.4.4 Input current

In determination of the input current, and where other test results could be affected, the following variables shall be considered and adjusted to give the most unfavourable results:

- loads due to optional features, offered or provided for by the manufacturer for inclusion in or with the equipment under test;
- loads due to other units of equipment intended by the manufacturer to draw power from the equipment under test;
- loads which could be connected to any standard supply outlets in **USER ACCESS AREAS** on the equipment, up to the value specified by the manufacturer.

It is permitted to use artificial loads to simulate such loads during testing.

B.5 Temperature measurement conditions

The test measurement set-up shall reproduce the most severe installation conditions. Where a maximum temperature (T_{max}) is specified for compliance with tests, it is based on the assumption that the room ambient air temperature will be 25°C when the equipment is operating. However, the manufacturer may specify a different max. ambient air temperature.

It is not necessary to maintain the ambient temperature (T_{amb}) at a specific value during tests, but it shall be monitored and recorded.

Temperatures (T) measured on the equipment shall conform with one of the following conditions, all temperatures being in °C:

if T_{max} is specified $(T - T_{amb}) \leq (T_{max} - T_{mra})$

if ΔT_{max} is specified $(T - T_{amb}) \leq (\Delta T_{max} + 25 - T_{mra})$

where T_{mra} is the maximum room ambient temperature permitted by the manufacturer's specification or 25 °C, whichever is greater.

The classification of insulating materials (classes A, E, B, F and H) is in accordance with IEC 60085.

B.6 Temperature measurement methods

Unless a particular method is specified, temperatures of windings shall be determined either by the thermocouple method or by the resistance method. If temperatures are determined by thermocouples, the measured values are increased by 10 K.

B.7 Conditions for audio amplifiers

Under **NORMAL OPERATING CONDITIONS**:

- a) The equipment shall be operated in such a way as to deliver 1/8 of the non-clipped output power to the rated load impedance using a sine wave of one 1 kHz, or where applicable, another frequency corresponding to the geometric mean of the upper and lower -3dB response points of the relevant part of the equipment. Alternatively, a band-limited pink noise signal may be used. The noise bandwidth of the test signal shall be limited by a filter of characteristic shown in figure B.1.

- b) The most unfavourable rated load impedance of any output circuit may be connected or not.
- c) Organs or similar instruments that have a tone-generator unit shall be operated with any combination of two bass pedal keys, if present, and ten manual keys depressed. All stops and tabs that can increase the output power shall be activated.

For audio amplifiers used in an electronic musical instrument that cannot generate a continuous tone, the signal described in a) shall be applied to the signal input terminals or to the appropriate input stage of the audio amplifier.

- d) Where the intended amplifier function depends on phase difference between two channels, there shall be a phase difference of 90 degrees between signals applied to the two channels. For surround-sound amplifiers, the rear channel shall be loaded to 1/16 of the non-clipped power.
- e) When determining whether a part or terminal contact is hazardous live, the equipment shall be operated with the signal described in a), sufficient in amplitude for the equipment to deliver maximum non-clipped output power into its rated load impedance. Open circuit output voltage shall be determined after the load is removed.

B.8 Simulated abnormal operating conditions

When applying abnormal operating conditions, parts, supplies, and media shall be in place if they are likely to have an affect on the outcome of the test.

The introduction of an abnormal operating condition shall be applied in turn one at a time. Faults, which are the direct consequence of the abnormal operating condition, are considered to be part of that abnormal operating condition.

Failure of **FUNCTIONAL INSULATION** and **BASIC INSULATION** shall be considered when selecting applicable abnormal operating conditions, however the failure of an element of in **DOUBLE INSULATION** or **REINFORCED INSULATION** is not considered.

The equipment, circuit diagrams and component specifications are examined to determine those abnormal operating conditions that might reasonably be expected to occur.

B.8.1 Covering of ventilation openings

Each group of ventilation openings that are likely to be covered simultaneously, shall be covered in turn and tested separately. Ventilating openings that are likely to be covered simultaneously are:

- openings on top of the equipment for example by a newspaper; or
- openings on the sides and the back, excluding the front, for example when pushed into a hanging curtain.

B.8.2 Setting of voltage selector

Portable equipment to be supplied from the a.c. **MAINS** and provided with a voltage setting device to be set by the **USER**, is connected to a supply voltage of 250 V a.c., with the **MAINS** voltage setting device at the most unfavourable position.

B.8.3 Maximum load at output terminals

Output terminals of equipment supplying power to other equipment, except **MAINS** socket-outlets directly connected to the **MAINS**, are connected to the most unfavourable load impedance, including short circuit.

B.8.4 Short circuit of insulation

B.8.4.1 Short circuit of basic insulation and supplementary insulation

Short-circuit across **CLEARANCES** and **CREEPAGE DISTANCES** if they are less than the values specified for **BASIC INSULATION** and **SUPPLEMENTARY INSULATION**.

B.8.4.2 Short circuit of functional insulation on coated and uncoated printed circuit boards

Short circuit across separation distances if they are less than the values specified in table B.1.

B.8.4.3 Short circuit of functional insulation of clearances

Short circuit across clearances if they are less than the values specified in table B.2.

Table B.1 – Minimum separation distance (mm) for printed circuit boards

Working voltage	Functional insulation, coated printed circuit board (Type II, see 3.2.4)	Functional insulation, uncoated printed circuit board
≤ 27 V r.m.s. or d.c.	0,1 mm	0,2 mm
≤ 63 V r.m.s. or d.c.	0,1 mm	0,4 mm
≤ 125 V r.m.s. or d.c.	0,2 mm	0,7 mm
≤ 160 V r.m.s. or d.c.	0,3 mm	0,8 mm
≤ 200 V r.m.s. or d.c.	0,4 mm	0,9 mm
≤ 250 V r.m.s. or d.c.	0,6 mm	0,1 mm
≤ 320 V r.m.s. or d.c.	0,8 mm	1,4 mm
≤ 400 V r.m.s. or d.c.	1,0 mm	1,9 mm
≤ 500 V r.m.s. or d.c.	1,3 mm	1,9 mm
≤ 630 V r.m.s. or d.c.	1,8 mm	2,3 mm
≤ 800 V r.m.s. or d.c.	2,4 mm	2,8 mm
≤ 1 000 V r.m.s. or d.c.	2,8 mm	3,3 mm
≤ 1 250 V r.m.s. or d.c.	3,4 mm	4,0 mm
≤ 1 600 V r.m.s. or d.c.	4,1 mm	
≤ 2 000 V r.m.s. or d.c.	5,0 mm	
≤ 2 500 V r.m.s. or d.c.	6,3 mm	
≤ 3 200 V r.m.s. or d.c.	8,2 mm	
≤ 4 000 V r.m.s. or d.c.	10 mm	
≤ 5 000 V r.m.s. or d.c.	13 mm	
≤ 6 300 V r.m.s. or d.c.	16 mm	
≤ 8 000 V r.m.s. or d.c.	20 mm	
≤10 000 V r.m.s. or d.c.	26 mm	
≤ 12 500 V r.m.s. or d.c.	33 mm	
≤ 16 000 V r.m.s. or d.c.	43 mm	
≤ 20 000 V r.m.s. or d.c.	55 mm	
≤ 25 000 V r.m.s. or d.c.	70 mm	
≤ 30 000 V r.m.s. or d.c.	86 mm	

Linear interpolation is permitted between the nearest two points, the calculated spacing being rounded up to the next higher 0,1 mm increment.

Table B.2 – Minimum clearances (mm) up to 2 000 m above sea level

Required withstand voltage	Functional insulation
≤ 400V peak or d.c.	0,1 mm
800V peak or d.c.	0,1 mm
1 000V peak or d.c.	0,2 mm
1 200V peak or d.c.	0,3 mm
1 500V peak or d.c.	0,5 mm
2 000V peak or d.c.	1 mm
2 500V peak or d.c.	1,5 mm
3 000V peak or d.c.	2 mm
4 000V peak or d.c.	3 mm
6 000V peak or d.c.	5,5 mm
8 000V peak or d.c.	8 mm
10 000V peak or d.c.	11 mm
12 000V peak or d.c.	14 mm
15 000V peak or d.c.	18 mm
25 000V peak or d.c.	33 mm
40 000V peak or d.c.	60 mm
50 000V peak or d.c.	75 mm
60 000V peak or d.c.	90 mm
80 000V peak or d.c.	130 mm
100 000V peak or d.c.	170 mm

B.8.5 Short circuit of electrodes in tubes and semiconductors

Short-circuit, or if applicable, interruption of electrodes in electronic tubes and semiconductors. One lead at a time is interrupted or any two leads connected together in turn.

B.8.6 Short circuit or disconnect of passive components

Short-circuit or disconnection, whichever is more unfavourable, of resistors, capacitors, windings, loudspeakers, varistors and other passive components.

These fault conditions do not apply to:

- PTC-S thermistors complying with IEC 60738;
- short-circuit between the input and output terminations of optocouplers, which comply with the relevant **CLEARANCES** and **CREEPAGE DISTANCES**;
- short-circuit between the input and output of transformers, which comply with the relevant **CLEARANCES** and **CREEPAGE DISTANCES**.

B.8.7 Step-up of supply voltage

Equipment which can be supplied by supply equipment for general use (adapters) shall be tested by using a test power supply as specified in table B.3 step by step upwards, starting with the value one step above the value specified for the rated supply voltage of the equipment under test. This test is not applied to equipment having a rated supply voltage higher than 12 V d.c.

Table B.3 – Test power supply

Rated supply voltage	Nominal no-load voltage	Internal resistance
1,5 V d.c.	2,25 V d.c.	0,75 Ω
3,0 V d.c.	4,50 V d.c.	1,50 Ω
4,5 V d.c.	6,75 V d.c.	2,25 Ω
6,0 V d.c.	9,00 V d.c.	3,00 Ω
7,5 V d.c.	11,25 V d.c.	3,75 Ω
9,0 V d.c.	13,50 V d.c.	4,50 Ω
12,0 V d.c.	18,00 V d.c.	6,00 Ω
<i>NOTE</i> The rated output current is 1 A.		

B.8.8 Earth faults of heating elements

Earth faults are simulated by:

- short circuiting of line to earth;
- interruption of the protective earth path.

B.8.9 Continuous operation of components

Motors, relay coils or the like, intended for **SHORT-TIME OPERATION** or **INTERMITTENT OPERATION**, are operated continuously if this can occur during operation of the equipment.

For equipment rated for only **SHORT-TIME OPERATION**, the duration of the test is equal to the **RATED OPERATING TIME**.

For equipment rated for **SHORT-TIME OPERATION** or **INTERMITTENT OPERATION**, the test is repeated until steady state conditions are reached, irrespective of the operating time. For this test the **THERMOSTATS**, **TEMPERATURE LIMITERS** and **THERMAL CUT-OUTS** are not short-circuited.

In **SECONDARY CIRCUITS**, where a hazard is likely to occur, electromechanical components other than motors which are normally energized intermittently a fault shall be simulated in the drive circuit to cause continuous energizing of the component.

The duration of the test shall be as follows:

- for equipment or components whose failure to operate is not evident to the USER: as long as necessary to establish steady conditions or up to the interruption of the circuit due to other consequences of the simulated fault condition, whichever is the shorter; and
- for other equipment and components: 5 min or up to interruption of the circuit due to a failure of the component (e.g. burn-out) or to other consequences of the simulated fault condition, whichever is shorter.

B.8.10 Reverse battery polarity

If it is possible to insert **USER** replaceable batteries with reversed polarity, the equipment is tested with one or more batteries reversed. See also annex N.

B.8.11 Blocking of motors

Motors are stalled, if this is possible during the use of the equipment by internal or external influences.

NOTE

See also annex J.

B.8.12 Maximum power to audio amplifier

The equipment shall be operated so as to deliver the most unfavourable output power from zero up to the maximum attainable output power to the rated load impedance or, if applicable, to the most unfavourable load impedance connected to the output terminals including a short-circuit and an open circuit.

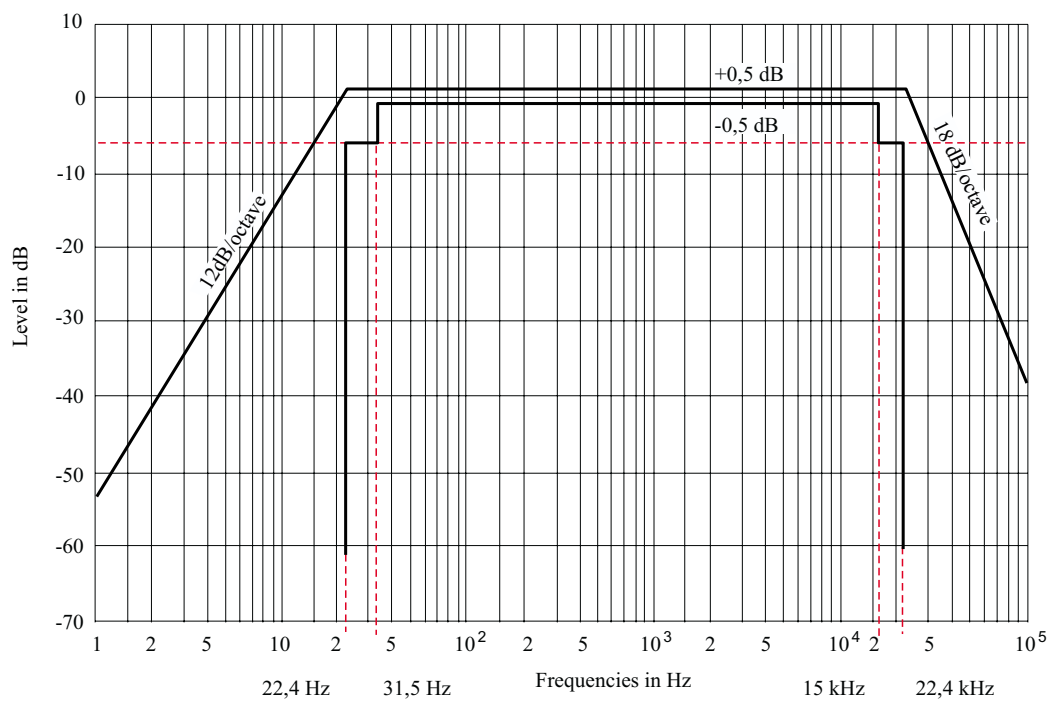

98-00115-A

Figure B.1 – Band-pass filter for wide-band noise measurement

Annex C
(normative)
Test probe

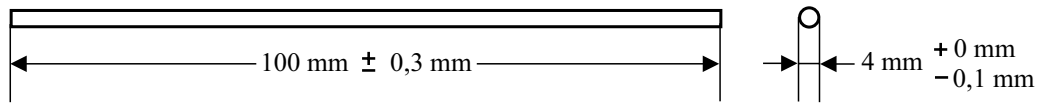

99-0033-A

Figure C.1 - Test probe

Annex D

(normative)

Test generators

D.1 General

This annex describes the characteristics of two impulse test generators. These circuits produce test pulses as referenced in table D.1. In this table:

- the reference 1 surge is typical of voltages induced into telephone wires and coaxial cables in long outdoor cable runs due to lightning strikes to their earthing shield;
- the reference 2 surge is typical of earth potential rises due to either lightning strikes to power lines or power line faults;
- the reference 3 surge is typical of voltages induced into antenna system wiring due to nearby lightning strikes to earth.

NOTE 1

Extreme care is necessary when using these test generators due to the high electric charge stored in the capacitor C_1 .

D.2 ITU-T test generators

The circuit in figure D.1, using the component values in references 1 and 2 of table D.1, is used to generate impulses, the C_1 capacitor being charged initially to a voltage U_c .

The impulse test circuit reference 1 of table D.1 for the 10/700 μ s impulse (10 μ s virtual front time, 700 μ s virtual time to half value) is that specified in ITU-T Recommendation K.17 to simulate lightning interference in the **TELECOMMUNICATION NETWORK**.

The impulse test circuit reference 2 of table D.1 for the 1,2/50 μ s impulse (1,2 μ s virtual front time, 50 μ s virtual time to half value) is that specified in IEC 60060 to simulate transients in power distribution systems.

The impulse wave shapes are under open-circuit conditions and can be different under load conditions.

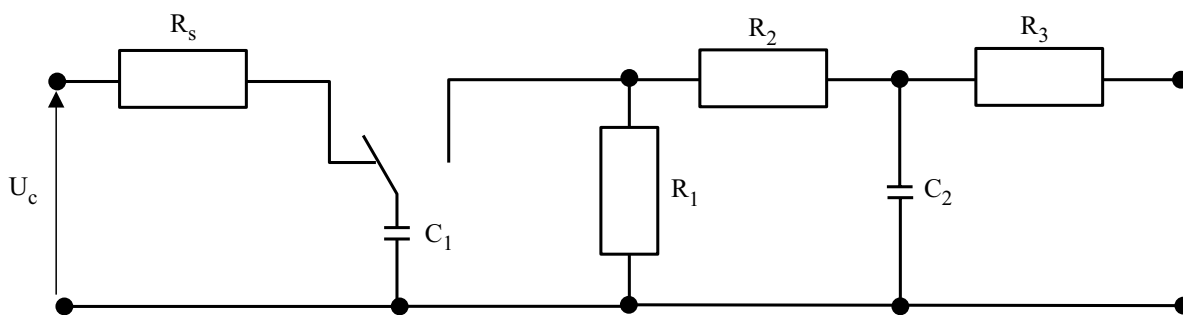

99-0003-A

Figure D.1 - ITU-T Impulse generating circuit

D.3 Antenna interface test generator

The circuit in figure D.2, using the component values reference 3 in table D.1, is used to generate impulses, the C_1 capacitor being charged initially to a voltage U_c . The switch used in figure D.2 is a critical part of the circuit, see figure D.3.

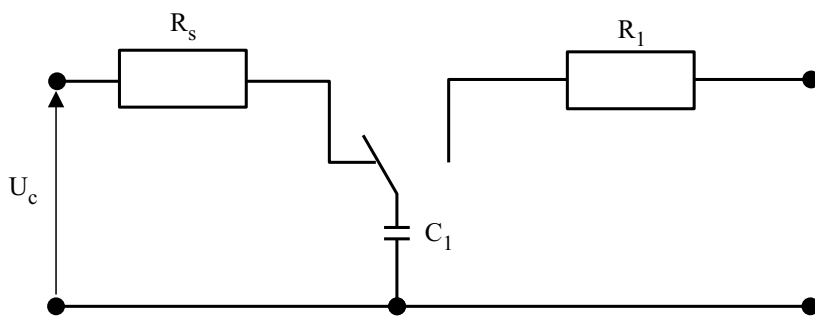

99-0002-A

Figure D.2 - Antenna interface test generator circuit

Table D.1 - Component values for Figures D.1 and D.2

Reference	Test Impulse	Figure	R _s	C ₁	C ₂	R ₁	R ₂	R ₃
1	10/700 μF	D.1	-	20 μF	0,2 μF	50 Ω	15 Ω	25 Ω
2	1,2/50 μs	D.1	-	1 μF	33 nF	76 Ω	13 Ω	25 Ω
3	-	D.2	15 MΩ	1 nF	-	1 KΩ	-	-

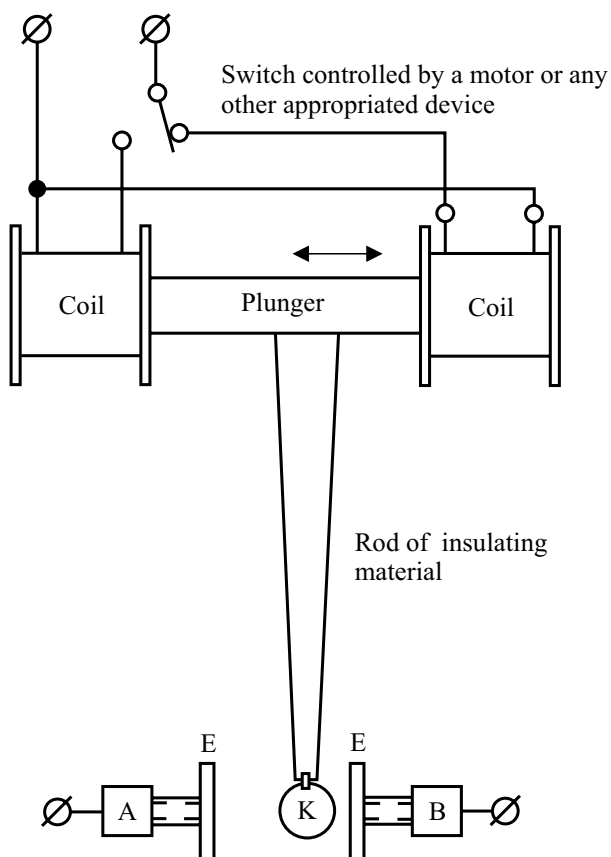

99-0032-A

Figure D.3 – Example of a switch to be used in the test circuit

Annex E

(normative)

Measuring network for touch currents

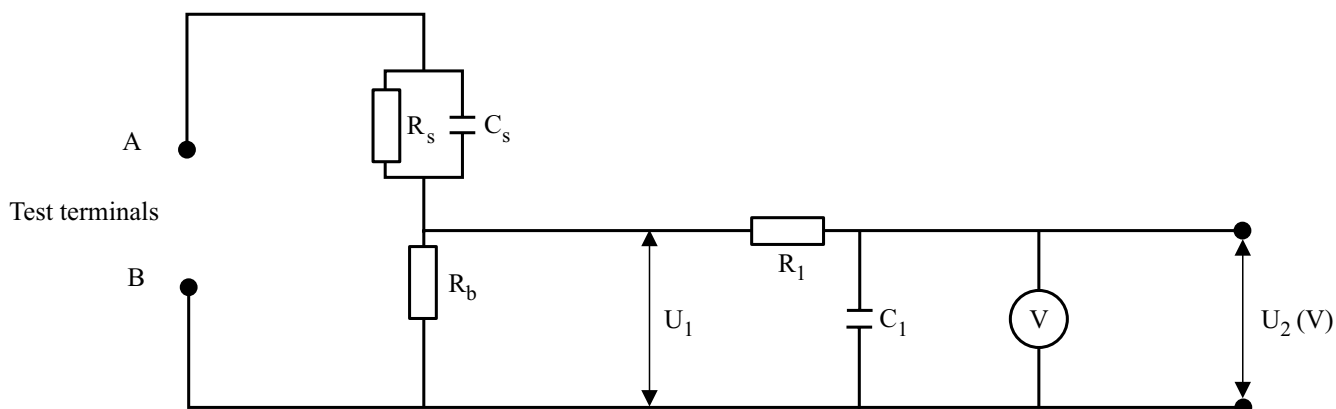

99-0004-A

$R_1 = 10 \text{ k}\Omega$

$R_s = 1500 \text{ }\Omega$

$R_b = 500 \text{ }\Omega$

$C_s = 0,22 \text{ }\mu\text{F}$

$C_1 = 0,022 \text{ }\mu\text{F}$

V: Voltmeter or oscilloscope
(r.m.s. or peak reading)

Input resistance: = $1 \text{ M}\Omega$

Input capacitance: = 200 pF

Frequency range: $15 \text{ Hz to } 1 \text{ MHz}$
and d.c. respectively

TOUCH CURRENT = $U_2/500$ (peak value).

Figure E.1 – Measuring network for touch currents according to IEC 60990

The measuring instrument is calibrated by comparing the frequency factor of U_2 with the solid line in figure F.2 of IEC 60990 at various frequencies. A calibration curve is constructed showing the deviation of U_2 from the ideal curve as a function of frequency.

NOTE

Appropriate measures should be taken to obtain the correct value in case of non-sinusoidal waveforms.

Annex F

(normative)

Marking and instructions

F.1 Introduction

Equipment marking, on the outside as well as inside, is needed for proper connection, use and servicing.

Safety instructions might be needed to ensure proper installation, interconnection, operation, maintenance and servicing.

Where safety markings need to be on the equipment, preference should be given to graphical symbols in accordance with IEC 60417 and ISO 3864. This may be a combination of marking signs and information signs. In the absence of suitable symbols in IEC 60417-1 the manufacturer may design specific graphical symbols. In all cases the meaning of the markings shall be explained in the relevant documentation.

Where verbal warnings are given they should be in a language acceptable to the country where the equipment is intended to be used

NOTE 1

For marking of components the relevant component standards apply.

F.2 Marking

Equipment shall bear markings in accordance with F.2.1 to F.2.1.4.

F.2.1 General

Markings shall be permanent and comprehensible.

Except for marking of internal parts, these shall be easily discernible on the equipment when ready for use.

The marking should preferably be on the exterior of the equipment, excluding the bottom. It is, however, permitted to have it in an area that is easily accessible by hand, for example under a lid, or on the exterior of the bottom of a portable equipment or an equipment with a mass not exceeding 7 kg, provided that the location of the marking is given in the instructions for use.

For **PERMANENTLY CONNECTED EQUIPMENT**, markings are permitted in the installation instructions.

Markings applying to the equipment as a whole shall not be put on parts which can be removed by a **USER** without the use of a **TOOL**.

For rack or panel mounted equipment, markings are permitted to be on any surface that becomes visible after removal of the equipment from the rack or panel.

Letter symbols for quantities and units shall be in accordance with IEC 60027.

Graphical symbols shall be in accordance with IEC 60417 and ISO 7000, as appropriate.

Markings which are printed or screened on the equipment shall contrast with the background.

Markings which are moulded or engraved shall have a depth or be raised to a height of minimum 0.5 mm, unless contrasting colours are used.

F.2.1.1 Identification





The equipment shall, as a minimum, be marked with the following:

- manufacturer's or responsible vendor's name, trade mark or identification mark;
- model number, name or other means to identify the equipment.

F.2.1.2 Supply ratings

The equipment shall be marked with the following information.

a) Nature of supply:

- a.c. only with the symbol:  (IEC 60417-2; -5032)
- d.c. only with the symbol:  (IEC 60417-2; -5031)
- both a.c. and d.c. with the symbol:  (IEC 60417-2; -5033)
- three-phase a.c. systems with the symbol: 3 

b) Rated supply voltage or range of the rated supply voltages which can be applied without operating a voltage setting device.

Equipment which can be set to different rated supply voltages or ranges of rated supply voltages shall be so constructed that the indication of the voltage or range of voltages to which the equipment is set, is discernible on the equipment when ready for use;

A solidus shall be used for user selectable ratings, for example “110/230 V” and a hyphen shall be used for a rating range, for example “110-230 V”;

- c) Rated **MAINS** frequency (or range of frequencies) in hertz, if safety is dependent on the use of the correct **MAINS** frequency;
- d) Rated current consumption or rated power consumption of equipment which can be supplied by supply equipment for general use. As an alternative the information may be given in the instruction manual.
- e) Rated current consumption marking for equipment intended for connection to an a.c. **MAINS** other than single phase, for **PERMANENTLY CONNECTED EQUIPMENT** and for equipment for professional use.

F.2.1.3 Terminals and operating devices

Terminals and operating devices shall be marked as follows:

a) The wiring terminal intended for connection of the protective earthing conductor associated with the supply wiring:



(IEC 60417-2; -5019)

This symbol shall not be used for other earthing terminals.

A wiring terminal intended exclusively for connection of the a.c. **MAINS** neutral conductor, if any, shall be indicated by the capital letter “N”.

These indications shall not be placed on screws, removable washers or other parts which can be removed when conductors are being connected.

b) Terminals which are **HAZARDOUS LIVE** under **NORMAL OPERATING CONDITIONS**, except terminals for **MAINS**:



99-0010-A

(IEC 60417-1; 5036)

c) **STATIONARY EQUIPMENT** for multiple supply shall be marked with the following symbols, the number of power plugs indicating the number of supply circuits:



99-0009-A

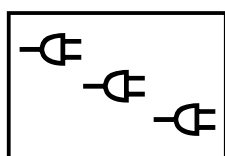

In case of a verbal warning it shall have the following or similar wording:

Warning:

Before obtaining access to terminals, all supply circuits must be disconnected.

This warning shall be placed in the vicinity of the terminal cover.

- d) Output terminals provided for supply of other equipment except **MAINS** shall be marked with the nominal output voltage and, in addition, the maximum output current, if with the most unfavourable load higher temperature rises than allowed can occur, unless the terminals are marked with the type references of the equipment which are permitted to be connected.

Socket-outlets providing mains power to other equipment shall be marked with the power or current which may be drawn.

If there is only one terminal provided for supply of other equipment, the marking may be put on the equipment at any place, taking into account the first paragraphs of F.2.1.

- e) If symbols are used on or near **MAINS** switches or circuit-breakers to indicate the on-position, the off-position or the stand by position of the equipment, the following applies:

ON symbol: (IEC 60417-2; -5007)

OFF symbol: (IEC 60417-2; -5008)

STAND-BY symbol: (IEC 60417-2; -5009)

It is permitted to use the symbols to indicate the position of any primary or secondary power switches, including isolating switches.

- f) Fuses shall be marked, close to the fuse holder, with the current rating and type, such as indication of rupturing speed, for example by the codes of IEC 60127. Where fuses of different voltage rating value could be fitted, the fuse voltage rating shall be indicated.

F.2.1.4 Equipment classification

The equipment shall be marked with the following information:

- the symbol for **CLASS II** equipment, if applicable:



(IEC 60417-2; -5172)

This symbol shall not be used on equipment which is partly of Class I construction, or is provided with a protective earth terminal.

- IP number according to degree of protection against ingress of water, if other than IPXO.

F.2.2 Test methodology

Compliance is checked by inspection, by tests according to F.2.2.1 and by measurement according to F.2.2.2.

F.2.2.1 Test on the permanence of the marking

In order to verify whether the marking is permanent, the following test is carried out.

The marking is rubbed by hand for 15 s with a piece of cloth soaked with water and, at a different place or on a second sample, for 15 s with a piece of cloth soaked with petroleum spirit.

NOTE

Petroleum spirit, to be used for reference purposes is defined as follows: The petroleum spirit is an aliphatic solvent hexane having a maximum aromatics content of 0,1 % by volume, a kauri-butanol value of 29, an initial boiling point of approximately 65 °C, a dry-point of approximately 69 °C and a specific mass of approximately 0,7 kg/l.

F.2.2.2 Measurement of power or current consumption

The measurement of power or current consumption is made under **NORMAL OPERATING CONDITIONS** (annex B.4), except that the equipment is connected to its rated supply voltage.

F.2.3 Compliance criteria

The markings shall be complete and applied correctly.

F.2.3.1 Rubbing test

After this test the marking shall be legible; it shall not be easily possible to remove marking plates and they shall show no curling.

F.2.3.2 Consumption measurement

The measured value shall not exceed the marked value by more than 10 %.

F.3 Instructions

F.3.1 General

For users, when information with regard to safety is required according to this standard, this information shall be given in an instruction for installation or use and supplied with the equipment. This information shall be given in a language acceptable to the country where the equipment is intended to be used and shall be accessible prior to the installation of the equipment.

NOTE

Reference is made to ISO/IEC Guide 37.

The instructions shall include the following as far as applicable.

- a) For **MAINS** powered equipment and for equipment producing internal voltages greater than 42,4 V (peak) a.c. or d.c., having no protection against splashing water according to IEC 60529, IPX4, the instructions for use shall state that the equipment shall not be exposed to dripping or splashing and that no objects filled with liquids, such as vases, shall be placed on the equipment.
- b) A statement in case equipment is intended exclusively for restricted access location.
- c) A warning that terminals marked with the symbol according to F.2.1.3 b) are **HAZARDOUS LIVE** and that the external wiring connected to these terminals requires installation by an instructed person or the use of ready-made leads or cords.
- d) A warning that equipment with **CLASS I** construction shall be connected to the protective earth connection (e.g. wall socket outlet).
- e) A warning for equipment which is connected to a main protective earth terminal, in case the touch current through a protective earth conductor exceeds 3,5 mA r.m.s., or in case connection ports allow the connection of multiple items of other equipment. In case of verbal warning it shall have the following or similar wording:

Warning

High leakage current possible

Earth connection essential before connecting supply

The graphical symbols are:



99-0011-A

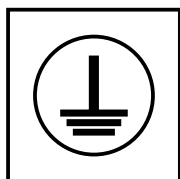

- f) Instructions to ensure correct and safe installation and interconnection of the equipment in multimedia systems.
- g) If an equipment is provided with a replaceable lithium battery, the following applies:

- if the battery is intended to be replaced by the **USER**, there shall be a warning close to the battery or in both the instructions for use and the service instructions;
- if the battery is not intended to be replaced by the **USER**, there shall be a warning close to the battery or in the service instructions
- The graphical symbols are:



99-0012-A

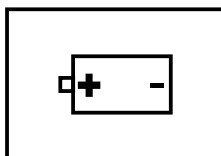

In case of a verbal warning it shall include the following or similar text:

CAUTION

**Danger of explosion if battery is incorrectly replaced.
Replace only with the same or equivalent type.**

- h) Explanation of symbols used.
- i) If a **PERMANENTLY CONNECTED EQUIPMENT** is not provided with an all-pole **MAINS** switch, the instructions shall state that an all-pole **MAINS** switch with a contact separation of at least 3 mm in each pole shall be incorporated in the electrical installation of the building.

NOTE

The following information with regard to safety is recommended to be included as far as applicable:

- *minimum distances around the equipment for sufficient ventilation;*
- *the ventilation should not be impeded by covering the ventilation openings with items, such as newspapers, table-cloths, curtains, etc.;*
- *no naked flame sources, such as lighted candles, should be placed on or near to the equipment;*
- *attention should be drawn to the environmental aspects of battery disposal;*
- *attention should be drawn to the correct replacements and disposal of hazardous chemical consumables*
- *the use of equipment in tropical and/or moderate climates.*
- *an instruction not to position the equipment so that it is difficult to operate the disconnecting device.*

F.3.1.1 Other information

Where in a manufacturer's service documentation, for example in circuit diagrams or lists of components, a symbol is used to indicate that a specific component shall be replaced only by the component specified in that documentation for safety reasons, the following symbol shall be used:



(ISO 7000-0434)

The colour of the symbol is optional, the printing can be as shown or with opposite colour setting.

The symbol may also be put adjacent to the relevant component, but shall not be placed on components.

F.3.2 Test methodology

Compliance is checked by inspection.

F.3.3 Compliance criteria

Instructions for installation or use or other documentation shall give the necessary safety information to the user and to service personnel.

Annex G

(normative) Components

G.1 Switches

Mechanical switches controlling currents exceeding 0,2 A a.c or d.c. shall meet the following requirements if the voltage across the open switch contacts exceeds 35 V (peak) a.c. or 24 V d.c.:

- Comply with the flammability category V-0 according to IEC 60707;
- Comply with the requirements of IEC 61058-1, whereby the following applies:
 - 10.000 operating cycles (see IEC 61058-1, 7.1.4.4);
 - the switch shall be suitable for use in a normal pollution situation;
 - the switch shall be of level 3 regarding the resistance to heat and fire;
 - for **MAINS** switches the speed of contact making and breaking shall be independent of the speed of actuation;
 - The characteristics of the switch with regard to the ratings and classification (see IEC 61058-1) shall be appropriate for the function of the switch under **NORMAL OPERATING CONDITIONS**. Compliance is checked according to IEC 61058-1.
- The switch shall be so constructed that it does not attain excessive temperatures during intended use. Compliance is checked in the on-position according to IEC 61058-1, 16.2.2 d, 1 and m, taking into account the total rated current of **MAINS** socket-outlets, if any, including peak surge current according to table 5.3.
- A **MAINS** switch controlling **MAINS** socket-outlets shall withstand the endurance test with an additional load according to IEC 61058-1, figure 9 and 10. The total rated current of the additional load shall correspond to the marking of the socket-outlets. The peak surge current of the additional load shall have a value as shown in table G.1.

Table G.1 – Peak surge current

Total rated current of the switch controlled socket-outlets	Peak surge current
≤ 0,5 A	20 A
> 0,5 A and ≤ 1,0 A	50 A
>1,0 A and ≤ 2,5 A	100 A
> 2,5 A	150 A

G.1.1 Test methodology

For **MAINS** switches the tests of IEC 61058-1 shall be applied with the modifications shown in G.1.

G.1.2 Compliance criteria

After the tests, the switch shall show no damage in the sense of this standard. In particular, it shall show no deterioration of its enclosure, no reduction of **CLEARANCES** and **CREEPAGE DISTANCES** and no loosening of electrical connections or mechanical fixings.

G.2 Thermal cut-outs

THERMAL CUT-OUTS shall meet either requirements a) or b) below.

a) The **THERMAL CUT-OUT** when tested as a separate component, shall comply with the requirements and tests of IEC 60730 series as far as applicable

- the thermal cut-out shall be of type 2 action (see IEC 60730-1, 6.4.2);
- the thermal cut-out shall have at least micro-disconnection (type 2B) (see IEC 60730-1, 6.4.3.2 and 6.9.2);
- the thermal cut-out shall have a trip-free mechanism in which contacts cannot be prevented from opening against a continuation of a fault (type 2E) (see IEC 60730-1, 6.4.3.5);
- the number of cycles of automatic action shall be at least
 - 3000 cycles for thermal cut-outs with automatic reset used in circuits which are not switched-off when the equipment is switched-off (see IEC 60730-1, 6.11.8),
 - 300 cycles for thermal cut-outs with no automatic reset which can be reset by hand from the outside of the equipment (see IEC 60730-1, 6.11.10),
 - 30 cycles for thermal cut-outs with no automatic reset and which cannot be reset by hand from the outside of the equipment (see IEC 60730-1, 6.11.11);
- the thermal cut-out shall be tested as designed for a long period of electrical stress across insulating parts (see IEC 60730-1, 6.14.2);
- the thermal cut-out shall meet the ageing requirements for an intended use of at least 10 000 h (see IEC 60730-1, 6.16.3).
- The characteristics of the thermal cut-out with regard to:
 - the ratings of the thermal cut-out (IEC 60730-1, clause 5);
 - the classification of the thermal cut-out according to
 - ◆ nature of supply (IEC 60730-1, 6.1),
 - ◆ type of load to be controlled (IEC 60730-1, 6.2),
 - ◆ degree of protection provided by enclosures against ingress of solid objects and dust (IEC 60730-1, 6.5.1),
 - ◆ degree of protection provided by enclosures against harmful ingress of water (IEC 60730-1, 6.5.2),
 - ◆ pollution situation for which the thermal cut-out is suitable (IEC 60730-1, 6.5.3),
 - ◆ maximum ambient temperature limit (IEC 60730-1, 6.7);

shall be appropriate for the application in the equipment under normal operating conditions and under fault conditions.

b) The **THERMAL CUT-OUT** when tested as a part of the equipment shall:

- have a trip-free mechanism in which contacts cannot be prevented from opening against a continuation of a fault, and;
- be aged for 300 h at a temperature corresponding to the ambient temperature of the thermal cut-out when the equipment is operated under normal operating conditions at an ambient temperature of 30 °C or higher if specified by the manufacturer, and;
- be subjected to a number of cycles of automatic action as specified under a) for a thermal cut-out tested as a separate component, by estimating the relevant fault conditions.

The test is made on three specimens.

G.2.1 Test Methodology

Compliance is checked according to the test specifications of IEC 60730 series by inspection and by measurement.

G.2.2 Compliance

Requirements of G.2 are fulfilled.

No sustained arcing shall occur during the test. After the test, the **THERMAL CUT-OUT** shall show no damage in the sense of this standard. In particular, it shall show no deterioration of its **ENCLOSURE**, no reduction of **CLEARANCES** and **CREEPAGE DISTANCES** and no loosening of electrical connections or mechanical fixings.

G.3 Thermal links

Thermal links shall meet either requirements a) or b) below.

a) The thermal link when tested as a separate component, shall comply with the requirements of IEC 60691. The characteristics of the thermal link with regard to

- the ambient conditions (see IEC 60691, 6.1);
- the circuit conditions (see IEC 60691, 6.2);
- the rating of the thermal link (see IEC 60691, 8 b);
- the suitability for sealing in or use with impregnating fluids or cleaning solvents (see IEC 60691, 8 c).

shall be appropriate for the application in the equipment under normal operating conditions and under fault conditions.

b) The thermal link when tested as a part of the equipment shall be

- aged for 300 h at a temperature corresponding to the ambient temperature of the thermal link when the equipment is operated under **NORMAL OPERATING CONDITIONS** at an ambient temperature of 30°C or higher if specified by the manufacturer, and
- subjected to such fault conditions of the equipment which cause the thermal link to operate. During the test no sustained arcing and no damage in sense of this standard shall occur, and
- capable of withstanding two times the voltage across the disconnection and have an insulation resistance of at least 0,2 MΩ, when measured with a voltage equal to two times the voltage across the disconnection.

Test Methodology

- If a thermal link is tested as a separate component (alternative a) above), compliance is checked according to the test specifications of IEC 60691, by inspection and measurement.
- If a thermal link is tested as a part of the equipment (alternative b) above), compliance is checked by inspection and by the specified tests in the given order. The test is made 10 times. No failure is allowed. The thermal link is replaced after each test.

G.4 PTC-S thermistors

PTC-S thermistors used in order to prevent the equipment from becoming unsafe within the sense of this standard shall comply with IEC 60738.

For PTC-S thermistors whose power dissipation exceeds 15 W for the rated zero-power resistance at an ambient temperature of 25 °C, the encapsulation or tubing shall comply with the flammability category V-1 or better according to IEC 60707.

Test Methodology

Compliance is checked by inspection and where applicable by the tests of IEC 60738.

G.5 Protective devices not mentioned in G.2 to G.4

Such protective devices, for example fusing resistors, fuse-links not standardized in IEC 60127 or miniature circuit breakers, shall have adequate rating including breaking capacity.

For non-resettable protective devices, such as fuse-links, a marking shall be located close to the protective device, so that correct replacement is possible.

G.5.1 Test methodology

Compliance is checked by inspection and during the tests under abnormal operating conditions (see 5.3.2).

The test under fault condition is carried out three times.

G.5.2 Compliance criteria

No failure is allowed.

G.6 High voltage components and assemblies

Components operating at voltages exceeding 4 kV (peak) and spark gaps provided to protect against overvoltages, if not otherwise covered by 5.3.5, shall not give rise to danger of fire to the surroundings of the apparatus, or to any other hazard within the sense of this standard.

The components shall be of flammability category V-1 according to IEC 60707, or better or pass the test of G.6.1.

Wiring working at voltages exceeding 4 kV (peak) a.c. or d.c. shall pass the test of U.4.

G.6.1 Test methodology

Compliance is checked by inspection or by the following test for high voltage transformers and multipliers.

Three specimens of the transformer with one or more high-voltage windings or of the high-voltage multipliers are subjected to the treatment specified under item a), followed by the test specified under item b).

a) Preconditioning

For transformers, a power of 10 W (a.c. at mains frequency or d.c.) is initially supplied to the high-voltage winding. This power is sustained for 2 min, after which it is increased by successive steps of 10 W at 2 min intervals to 40 W.

The treatment lasts 8 min or is terminated as soon as interruption of the winding or appreciable splitting of the protective covering occurs.

NOTE 1

Certain transformers are so designed that this preconditioning cannot be carried out. In such cases, only the test of item b) below is applied.

For high-voltage multipliers, a voltage taken from an appropriate high-voltage transformer, is supplied to each specimen, its output circuit being short-circuited.

The input voltage is adjusted so that the short-circuit current is initially $25 \text{ mA} \pm 5 \text{ mA}$. This is maintained for 30 min or is terminated as soon as any interruption of the circuit or appreciable splitting of the protective covering occurs.

NOTE 2

Where the design of a high-voltage multiplier is such that a short-circuit current of 25 mA cannot be obtained, a preconditioning current is used, which represents the maximum attainable current, determined either by the design of the multiplier or by its conditions of use in a particular apparatus.

b) Flame test

The specimen is subjected to the flammability test of U.2.

Annex H

(normative) Transformers

H.1 Overload test

If the tests in H.1 are carried out under simulated conditions on the bench, these conditions shall include any protection device which would protect the transformer in the complete equipment.

Transformers for switch mode power supply units are tested in the complete power supply unit or in the complete equipment. Test loads are applied to the output of the power supply unit.

A linear transformer or a ferro-resonant transformer has each secondary winding loaded in turn, with any other secondaries loaded between zero and their specified maxima to result in the maximum heating effect.

The output of a switch mode power supply is loaded to result in the maximum heating effect in the transformer.

Where an overload cannot occur, the tests of H.1 are not made.

Maximum temperatures of windings shall not exceed the values in table H.1 when measured as specified in B.5 and B.6, and determined as specified below:

- with external overcurrent protection: at the moment of operation, for determination of the time until the overcurrent protection operates, it is permitted to refer to a data sheet of the overcurrent protection device showing the trip time versus the current characteristics;
- with an automatic reset **THERMAL CUT-OUT**: after 4 h;
- with a manual reset **THERMAL CUT-OUT**: at the moment of operation;
- for current-limiting transformers: after temperature has stabilized.

Secondary windings which exceed the temperature limits but which become open circuit or otherwise require replacement of the transformer do not constitute a failure of this test, provided that no hazard is created in the meaning of this standard.

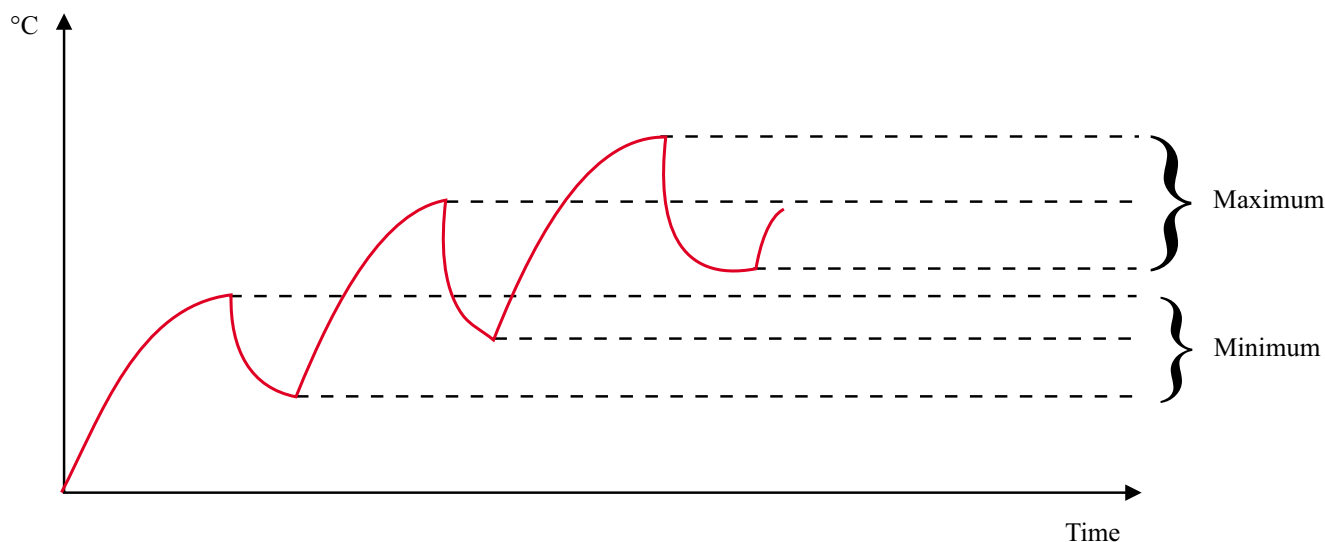

Figure H.1 - Determination of arithmetic average temperature

Table H.1 - Permitted temperature limits for transformer windings

	Maximum temperature				
	Class A	Class E	Class B	Class F	Class H
Protection by inherent or external impedance	150 °C	165 °C	175 °C	190 °C	210 °C
Protection by a protective device which operates during the first hour	200 °C	215 °C	225 °C	240 °C	260 °C
Protection by any protective device:					
• maximum after the first hour	175 °C	190 °C	200 °C	215 °C	235 °C
• arithmetic average during the 2 nd hour and during the 72 nd hour	150 °C	165 °C	175 °C	190 °C	210 °C

Condition to the table	
The arithmetic average temperature is determined as follows:	
The graph of temperature against time, while the power to the transformer is cycling on and off, is plotted for the period of test under consideration. The arithmetic average temperature (t_A) is determined by the formula:	
$t_A = \frac{t_{\max} + t_{\min}}{2}$	
where:	
<ul style="list-style-type: none"> • t_{\max} is the average of the maxima • t_{\min} is the average of the minima 	

H.2 Insulation

Insulation in transformers shall comply with the following requirements.

Windings and conductive parts of transformers shall be treated as parts of the circuits to which they are connected, if any. The insulation between them shall comply with the relevant requirements of 3.1 and pass the relevant dielectric strength tests, according to the application of the insulation in the equipment.

Precautions shall be taken to prevent the reduction below the required minimum values of **CLEARANCES** and **CREEPAGE DISTANCE** that provide **BASIC INSULATION**, **SUPPLEMENTARY INSULATION** or **REINFORCED INSULATION** by:

- displacement of windings, or their turns;
- displacement of internal wiring or wires for external connections;
- undue displacement of parts of windings or internal wiring, in the event of rupture of wires adjacent to connections or loosening of the connections;
- bridging of insulation by wires, screws, washers and the like should they loosen or become free.

It is not expected that two independent fixings will loosen at the same time.

All windings shall have the end turns retained by positive means.

NOTE

Examples of acceptable forms of construction are the following (there are other acceptable forms of construction):

- *windings isolated from each other by placing them on separate limbs of the core, with or without spools;*
- *windings on a single spool with a partition wall, where either the spool and partition wall are pressed or moulded in one piece, or a pushed-on partition wall has an intermediate sheath or covering over the joint between the spool and the partition wall;*

- *concentric windings on a spool of insulating material without flanges, or on insulation applied in thin sheet form to the transformer core;*
- *insulation is provided between windings consisting of sheet insulation extending beyond the end turns of each layer;*
- *concentric windings, separated by an earthed conductive screen which consists of metal foil extending the full width of the windings, with suitable insulation between each winding and the screen. The conductive screen and its lead-out wire have a cross section sufficient to ensure that on breakdown of the insulation an overload device will open the circuit before the screen is destroyed. The overload device may be a part of the transformer.*

Test methodology

Compliance is checked by inspection and measurement.

If a transformer is fitted with an earthed screen for protective purposes, the transformer shall pass the test of 3.3.1.1 between the earthed screen and the earthing terminal of the transformer.

No dielectric strength test applies to insulation between any winding and the core or screen, provided that the core or screen is totally enclosed or encapsulated and there is no electrical connection to the core or screen. However, the tests between windings which have terminations continue to apply.

Annex J

(normative)

Motor tests under abnormal conditions

J.1 General requirements

Motors, other than d.c. motors in **SECONDARY CIRCUITS**, shall pass the tests of clauses J.4 and J.5 and, where applicable, clauses J.8, J.9 and J.10, except for the following motors which are not required to pass the test of clause J.4:

- motors which are used for air-handling only and where the air-propelling component is directly coupled to the motor shaft, and
- shaded pole motors whose values of locked-rotor current and no-load current do not differ by more than 1 A and have a ratio of not more than 2/1.

D.c. motors in **SECONDARY CIRCUITS** shall pass the tests of clauses J.6, J.7 and J.10 except for motors which by their intrinsic operation normally operate under locked-rotor conditions, such as stepper motors, are not tested.

J.2 Test conditions

Unless otherwise specified in this annex, during the test the equipment is operated at **RATED VOLTAGE**, or at the highest voltage of the **RATED VOLTAGE** range.

The tests are carried out either in the equipment or under simulated conditions on the bench. It is permitted to use separate samples for bench tests. Simulated conditions include:

- any protection devices which would protect the motor in the complete equipment, and
- use of any mounting means which may serve as a heat sink to the motor frame.

Temperatures of windings are measured as specified in B.5. Where thermocouples are used they are applied to the surface of the motor windings. Temperatures are determined at the end of the test period where specified, otherwise when the temperature has stabilised, or at the instant of operation of fuses, **THERMAL CUT-OUTS**, motor protection devices and the like.

For totally enclosed, impedance-protected motors, the temperatures are measured by thermocouples applied to the motor case.

When motors without inherent thermal protection are tested under simulated conditions on the bench, the measured winding temperature is adjusted to take into account the ambient temperature in which the motor is normally located within the equipment

J.3 Maximum temperatures

For the tests in clauses J.5, J.7, J.8 and J.9 the temperature limits, as specified in table J.1, shall not be exceeded.

Table J.1 - Permitted temperature limits for motor windings
(except for running overload test)

	Maximum temperature				
	Class A	Class E	Class B	Class F	Class H
Protection by inherent or external impedance	150 °C	165 °C	175 °C	190 °C	210 °C
Protection by a protective device which operates during the first hour	200 °C	215 °C	225 °C	240 °C	260 °C
Protection by any protective device:					
• maximum after the first hour	175 °C	190 °C	200 °C	215 °C	235 °C
• arithmetic average during the 2 nd hour and during the 72 nd hour	150 °C	165 °C	175 °C	190 °C	210 °C

Condition to the table	
The arithmetic average temperature is determined as follows:	
The graph of temperature against time, while the power to the motor is cycling on and off, is plotted for the period of test under consideration. The arithmetic average temperature (t_A) is determined by the formula:	
$t_A = \frac{t_{\max} + t_{\min}}{2}$	
where:	
<ul style="list-style-type: none"> • t_{\max} is the average of the maxima • t_{\min} is the average of the minima 	

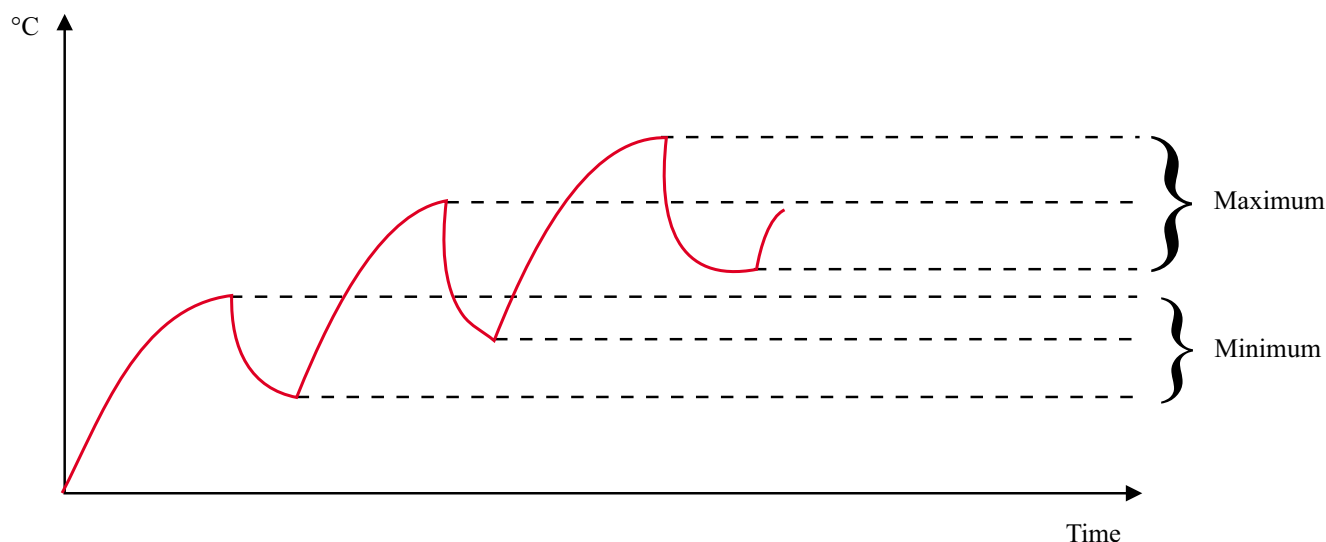

93-0094-B

Figure J.1 - Determination of arithmetic average temperature

For the tests in clauses J.4 and J.6 the temperature limits, as specified in table J.2, shall not be exceeded for each class of insulating material.

Table J.2 - Permitted temperature limits for running overload tests

Maximum temperature (°C)				
Class A	Class E	Class B	Class F	Class H
140	155	165	180	200

J.4 Running overload test

A running overload protection test is carried out by operating the motor under **NORMAL OPERATING CONDITIONS**. The load is then increased so that the current is increased in appropriate gradual steps, the motor supply voltage being maintained at its original value. When steady conditions are established, the load is again increased. The load is thus progressively increased in appropriate steps but without reaching locked-rotor condition (see clause J.5) until the overload protection device operates.

The motor winding temperatures are determined during each steady period and the maximum temperature recorded shall not exceed the values specified in table J.2.

J.5 Locked-rotor overload test

A locked-rotor test is carried out starting at room temperature.

The duration of the test is as follows:

- a motor protected by inherent or external impedance is operated on locked-rotor for 15 days except that testing is discontinued when the windings of the motor reach a constant temperature
- a motor with an automatic reset protection device is cycled on locked-rotor for 18 days;
- a motor with a manual reset protection device is cycled on locked-rotor for 60 cycles, the protection device being reset after each operation as soon as possible for it to remain closed, but after not less than 30 s;
- a motor with a non-resettable protection device is operated until the device operates.

Temperatures are recorded at regular intervals during the first three days for a motor with inherent or external impedance protection or with an automatic reset protection device, or during the first ten cycles for a motor with a manual reset protection device, or at the time of operation of a non-resettable protection device.

The temperatures shall not exceed the values specified in table J.1.

During the test, protection devices shall operate reliably without permanent damage to the motor including:

- severe or prolonged smoking or flaming;
- electrical or mechanical breakdown of any associated component part such as a capacitor or starting relay;
- flaking, embrittlement or charring of insulation.
- deterioration of the insulation.

Discoloration of the insulation is permitted but charring or embrittlement to the extent that insulation flakes off or material is removed when the winding is rubbed with the thumb is not permitted.

After the period specified for temperature measurement, the motor shall withstand the dielectric strength test in 3.2.3.1.3 after the insulation has cooled to room temperature and with test voltages reduced to 0,6 times the specified values. No further dielectric strength test is required.

NOTE

Continuation of the test of an automatic reset protection device beyond 72 h, and of a manual reset protection device beyond 10 cycles, is for the purpose of demonstrating the capability of the device to make and break locked-rotor current for an extended period of time.

J.6 Running overload test for d.c. motors in secondary circuits

The running overload test is carried out only if a possibility of an overload occurring is determined by inspection or by review of the design. The test need not be carried out, for example, where electronic drive circuits maintain a substantially constant drive current.

The test is carried out by operating the motor under **NORMAL OPERATING CONDITIONS**. The load is then increased so that the current is increased in appropriate gradual steps, the motor supply voltage being maintained at its original value. When steady conditions are established the load is again increased. The load is thus progressively increased in appropriate steps until either the overload protection device operates or the winding becomes an open circuit.

The motor winding temperatures are determined during each steady period and the maximum temperature recorded shall not exceed the value in table J.2, except that, where difficulty is experienced in obtaining accurate temperature measurements, due to the small size or unconventional design of the motor, it is permitted to use the following test instead of temperature measurement.

During the running overload test, the motor is covered with a single layer of bleached cotton cheesecloth of approximately 40 g/m². There shall be no ignition of the cheesecloth during the test or at its conclusion.

Compliance with either method is acceptable; it is not necessary to comply with both methods.

J.7 Locked-rotor overload test for d.c. motors in secondary circuits

J.7.1 General

Motors shall pass the test in J.7.2, except that, where difficulty is experienced in obtaining accurate temperature measurements, because of the small size or unconventional design of the motor, the method of J.7.3 can be used instead. Compliance may be established by either method.

Following the test of J.7.2 or J.7.3, as applicable, if the motor voltage exceeds 42,4 V peak, or 70 V d.c., and after the motor has cooled to room temperature, the motor shall withstand the dielectric strength test in 3.2.3.1.3 and with test voltages reduced to 0,6 times the specified values.

J.7.2 Test procedure and compliance criteria

The motor is operated with its rotor locked for 7 h or until steady conditions are established. Temperatures shall not exceed the values specified in table J.1.

J.7.3 Alternative test procedure and compliance criteria for J.7.2

The motor is placed on a wooden board which is covered with a single layer of wrapping tissue, and the motor in turn covered with a single layer of bleached cotton cheesecloth of approximately 40 g/m².

NOTE

Wrapping tissue is defined in ISO 4046: a soft and strong lightweight wrapping paper of grammage generally between 12 g/m² and 30 g/m².

The motor is then operated with the rotor locked for 7 h or until steady conditions are established. At the conclusion of the test there shall be no ignition of the wrapping tissue or cheesecloth.

J.8 Test for motors with capacitors

Motors having phase-shifting capacitors are tested under locked-rotor conditions with the capacitor short-circuited or open-circuited (whichever is the more unfavourable).

The short-circuit test is not made if the capacitor is so designed that, upon failure, it will not remain short-circuited.

Temperatures shall not exceed the values specified in table J.1.

NOTE

Locked-rotor is specified because some motors may not start and variable results could be obtained.

J.9 Test for three-phase motors

Three-phase motors are tested under **NORMAL OPERATING CONDITIONS**, with one phase disconnected, unless circuit controls prevent the application of voltage to the motor when one or more supply phases are missing.

The effect of other loads and circuits within the equipment may necessitate that the motor be tested within the equipment and with the three supply phases disconnected one at a time.

Temperatures shall not exceed the values specified in table J.1.

J.10 Test for series motors

Series motors are operated at a voltage equal to 1,3 times their rated voltage for 1 min with the lowest possible load.

After the test, windings and connections shall not have worked loose and no hazard shall be present within the meaning of this standard.

Annex K

(normative)

Insulated winding wires for use without interleaved insulation

K.1 General

This annex specifies winding wires whose insulation may be used to provide **BASIC INSULATION**, **SUPPLEMENTARY INSULATION**, **DOUBLE INSULATION** or **REINFORCED INSULATION** in wound components without interleaved insulation.

This annex covers round winding wires having diameters between 0,2 mm and 1,0 mm. For other sizes, reference should be made to IEC 60851 standards.

K.2 Sampling tests

The wire shall pass the following type tests, carried out at a temperature between 15 °C and 35 °C and a relative humidity between 45 % and 75 %, unless otherwise specified.

K.2.1 Dielectric strength

The test sample is prepared according to IEC 60851-5: 1996, 4.4.1 (for a twisted pair). The sample is then subjected to the relevant test of 3.2.3.1.1 of this standard with a test voltage not less than twice the appropriate voltage of table 3.5 of this standard or 6 kV r.m.s., whichever is greater.

K.2.2 Flexibility and adherence

Test 8 of IEC 60851-3: 1996, 5.1.1 shall be used, using the mandrel diameters of table K.1.

The test sample is then examined in accordance with IEC 60851-3: 1996, 5.1.1.4, followed by the relevant test of 3.2.3.1.1 of this standard with a test voltage not less than the appropriate voltage of table 3.5 of this standard or 3 kV r.m.s., whichever is greater.

Table K.1 - Mandrel diameter

Nominal conductor diameter	Mandrel diameter
0,20 mm to 0,34 mm	4,0 mm ± 0,2 mm
0,35 mm to 0,49 mm	6,0 mm ± 0,2 mm
0,50 mm to 0,74 mm	8,0 mm ± 0,2 mm
0,75 mm to 1,00 mm	10,0 mm ± 0,2 mm

The tension to be applied to the wire during winding on the mandrel is calculated from the wire diameter to be equivalent to 118 MPa ± 10 % (118 kN/mm² ± 10 %)

K.2.3 Heat shock

Test 9 of IEC 60851-6: 1996, followed by the dielectric strength test of 3.2.3.1.3 with a voltage not less than the appropriate voltage of table 3.5 of this standard or 3 kV r.m.s., whichever is greater.

The oven temperature is the relevant temperature of the thermal class of insulation in table K. 2.3

The mandrel diameter and tension applied to the wire during winding on the mandrel are as in K.2.2.

The dielectric strength test is conducted at room temperature after removal from the oven.

Table K.2 - Oven temperature

Thermal class	A (105)	E (120)	B (130)	F (155)	H (180)
Oven temperature	200 °C ± 5 °C	215 °C ± 5 °C	225 °C ± 5 °C	240 °C ± 5 °C	260 °C ± 5 °C

K.2.4 Retention of dielectric strength after bending

Five samples are prepared as in **K.2.2** above and tested as follows. Each sample is removed from the mandrel, placed in a container and positioned so that can be surrounded by at least 5 mm of metal shot. The ends of the conductor in the sample shall be sufficiently long to avoid flash over. The shot shall be not more than 2 mm in diameter and shall consist of balls of stainless steel, nickel or nickel plated iron. The shot is gently poured into the container until the sample under test is covered by at least 5 mm of shot. The shot shall be cleaned periodically with a suitable solvent (e.g. 1,1,1, - trichloroethane).

NOTE

The above test procedure is reproduced from 4.6.1 c) of IEC 60851-5:1985 (second edition including amendment 1) now withdrawn. It is not included in the third edition of that standard.

The test voltage is not less than the appropriate voltage of table 3.5 of this standard or 3000V r.m.s., whichever is greater. It is applied between the shot and the conductor.

The mandrel diameter and tension applied to the wire during winding on the mandrel are as in **K.2**.

K.3 Testing during manufacture

The wire shall be subjected by the wire manufacturer to dielectric strength tests during manufacture as specified in **K.3.1** and **K.3.2**

K.3.1 Routine test

The test voltage for routine test shall be the appropriate voltage of table 3.6, with a minimum of 3 kV r.m.s. or 4,2 kV peak.

K.3.2 Sampling test

Twisted pair samples shall be tested in accordance with IEC 60851-5: 1996, 4.4.1. The minimum breakdown voltage shall be twice the appropriate voltage of table 3.6 of this standard, but not less than 6 kV r.m.s or 8,4 kV peak.

Annex L

(normative) Safety interlocks

L.1 General requirements

SAFETY INTERLOCKS shall be so designed that the hazard will be removed before the cover, door, etc. is in any position that will permit contact of the rigid test finger, test probe 11 of IEC 61032, with hazardous parts.

For protection against electric shock and energy hazards, removal, opening or withdrawal of the cover, door, etc., shall:

- necessitate previous de-energisation of such parts, or
- automatically initiate disconnection of the supply to such parts, and reduce within 2 s the voltage to 42,4 V peak, or 70 V d.c., or less, and the energy level to less than 20 J.

For a moving part which will continue to move through momentum and will continue to present a hazard (e.g. a spinning print drum), removal, opening or withdrawal of the cover, door, etc., shall:

- necessitate previous reduction of movement to an acceptably safe level, or
- automatically initiate reduction of the movement within 2 s to an acceptably safe level.

The following exceptions are permitted for a longer period than 2 s if there is a marking which tells the operator to wait for a longer period:

- temperatures of easily touched parts may exceed the values of table 5.2;
- for moving parts, the requirements of H.1 need not be met during the period specified.

Such markings shall be placed on covers and other parts which have to be removed to obtain access, and also on or beside the hazardous part.

Test Methodology

The voltage and/or energy level of parts at hazardous levels are monitored.

Compliance is checked by inspection, measurement and use of the rigid test finger, test probe 11 of IEC 61032.

L.2 Inadvertent reactivation

SAFETY INTERLOCKS shall be designed so that inadvertent reactivation of the hazard cannot occur when covers, guards, doors, etc. are not in the closed position.

Any accessible interlock which can be operated by means of the rigid test finger, test probe 11 of IEC 61032, is considered to be likely to cause inadvertent reactivation of the hazard.

SAFETY INTERLOCKS switches shall be selected taking into account the mechanical shock and vibration experienced in normal operation, so that this does not cause inadvertent switching to an unsafe condition.

Test Methodology

Compliance is checked by inspection and where necessary by a test with the rigid test finger, test probe 11 of IEC 61032.

With the doors and covers opened and the **SAFETY INTERLOCK** activated, the test finger is used to attempt to override the interlock.

L.3 Fail-safe operation

A **SAFETY INTERLOCK** system shall comply with either item a) or item b), as follows:

- a) the probable failure mode(s) of the interlock system will not create a hazard for which protection is required;
- b) an assessment of the interlock means, equipment, circuit diagrams and available data will result in the conclusion that failure is not likely to occur during the normal life of the equipment.

Test Methodology

Compliance is checked by assessment of the system and completion of the test cycles described below.

Interlocks with moving parts are cycled to switch the least favourable load in normal use. The number of cycles is twice the maximum number likely to occur during the expected life of the equipment but not less than 10 000 operations.

Reed switches in **ELV CIRCUITS** shall be subjected to 100 000 cycling operations.

Assessment of compliance with a) includes not only electro-mechanical components but also, for example, failure of a single semi-conductor device, together with any consequential failure or malfunction.

It is permitted to use simulated interlock systems for tests.

L.4 Override

Where it may be necessary for service personnel to override a safety interlock, the override system shall:

- require an intentional effort to operate, and
- reset automatically to normal operation when servicing is complete, or shall prevent normal operation unless the **SERVICE PERSONNEL** have carried out restoration, and
- require a **TOOL** for operation when in **USER ACCESS AREAS** and shall not be operable with the test finger.

Test Methodology

Compliance is checked by inspection, operation and test with the test finger where necessary.

The operation of service override functions of safety interlocks are tested by simulating service activities as follows:

- Operation of the interlock override to ensure that it requires an intentional effort to operate;
- Reassembly of the unit to ensure automatic reset when service is complete.
- Attempted service override of **SAFETY INTERLOCKS** in **USER ACCESS AREAS** with the test finger and verification that they require a **TOOL** to operate.

L.5 Mechanically operated interlock switches

A mechanical interlock switch shall either comply with L.5.1 or pass the tests of L.5.2 and L.5.3

L.5.1 Contact gaps

The contact gap shall not be less than that for the primary power **DISCONNECT DEVICE** (see annex M) if located in the **PRIMARY CIRCUIT**. For other circuits, the contact gap shall not be less than the **CLEARANCE** values in 3.2.1.

Test Methodology

Compliance is checked by inspection and measurement.

CLEARANCE of contact gaps of interlock switches are measured as follows:

- Interlock switches located in primary circuits are measured for a contact separation of 3 mm.
- Interlock switches located in secondary circuits are measured for a contact separation per the clearance values of table 3.4.

L.5.2 Reliability

The switch shall successfully perform twice the maximum number of cycles likely to occur during the expected life of the equipment..

Reed switches in **ELV CIRCUITS** shall withstand 100 000 cycling operations.

Test Methodology

Compliance is checked by inspection and test.

The switch shall successfully perform twice the maximum number of cycles likely to occur during the expected life of the equipment at the rate of 6-10 cycles per minute, making and breaking 150 percent of the current imposed in the application except that for a switch that switches a motor load, the test is conducted with the rotor of the motor in a locked condition.

Reed switches in **ELV CIRCUITS** shall be subjected to 100 000 cycling operations during the test of L.3.

Except for reed switches in **ELV CIRCUITS**, a dielectric strength test, as specified in 3.2.3.1.3 for **REINFORCED INSULATION**, is applied between the contacts after the tests.

Annex M

(normative) Disconnect devices

M.1 General requirements

A **DISCONNECT DEVICE** shall be provided to disconnect the equipment from the supply.

The **DISCONNECT DEVICE** shall have a contact separation of at least 3 mm and, when incorporated in the equipment, shall be connected as closely as practicable to the incoming supply.

Functional switches are permitted to serve as **DISCONNECT DEVICES** if they comply with all the requirements for **DISCONNECT DEVICES**. However, these requirements do not apply to functional switches where other means of isolation are provided.

The following types of **DISCONNECT DEVICES** are permitted:

- the plug on the power supply cord,
- an appliance coupler,
- isolating switches,
- circuit breakers
- any equivalent device offering a degree of safety equal to the above.

M.1.1 Permanently connected equipment

For **PERMANENTLY CONNECTED EQUIPMENT** the **DISCONNECT DEVICE** shall be incorporated in the equipment, unless the equipment is accompanied by installation instructions stating that an appropriate **DISCONNECT DEVICE** shall be provided as part of the building installation.

NOTE

*External **DISCONNECT DEVICES** will not necessarily be supplied with the equipment.*

M.1.2 Parts which remain energised

Parts on the supply side of a **DISCONNECT DEVICE** in the equipment which remain energised when the **DISCONNECT DEVICE** is switched off shall be guarded to reduce the risk of accidental contact by **SERVICE PERSONNEL**.

As an alternative instructions shall be provided in the service manual.

M.1.3 Switches in flexible cords

When an isolating switch is used, it shall not be fitted in an a.c. **MAINS** supply cord.

M.1.4 Single phase equipment

For single-phase equipment, the **DISCONNECT DEVICE** shall disconnect both poles simultaneously, except that a single-pole **DISCONNECT DEVICE** can be used to disconnect the phase conductor when it is possible to rely on the identification of the neutral in the **MAINS**. Instructions shall be given for the provision of an additional two-pole **DISCONNECT DEVICE** in the building installation when the equipment is used where identification of the neutral in the **MAINS** is not possible.

NOTE

*Three examples of cases where a two-pole **DISCONNECT DEVICE** is required are:*

- on equipment supplied from an IT power system;
- on **PLUGGABLE EQUIPMENT** supplied through a reversible appliance coupler or a reversible plug (unless the appliance coupler or plug itself is used as the **DISCONNECT DEVICE**);
- on equipment supplied from a socket-outlet with indeterminate polarity.

M.1.5 Three-phase equipment

For three-phase equipment, the **DISCONNECT DEVICE** shall disconnect simultaneously all phase conductors of the supply. For equipment requiring a neutral connection to an IT power system, the **DISCONNECT**

DEVICE shall be a four-pole device and shall disconnect all phase conductors and the neutral conductor. If this four-pole device is not provided in the equipment, the installation instructions shall specify the need for its provision as part of the building installation.

If a **DISCONNECT DEVICE** interrupts the neutral conductor, it shall simultaneously interrupt all phase conductors.

M.1.6 Switches as disconnect devices

Where the **DISCONNECT DEVICE** is a switch incorporated in the equipment, its on and off positions shall be marked in accordance with annex F.

M.1.7 Plugs as disconnect devices

Where a plug on the power supply cord is used as the **DISCONNECT DEVICE**, the installation instructions shall state that for **PLUGGABLE EQUIPMENT**, the socket-outlet shall be installed near the equipment and shall be easily accessible. For **PLUGGABLE EQUIPMENT** intended for **USER** installation, the installation instructions shall be made available to the **USER**.

M.1.8 Devices for pluggable equipment

For **CLASS I** equipment, the supply plug or appliance coupler, if used as the **DISCONNECT DEVICE**, shall make the protective earthing connection earlier than the supply connections and shall break it later than the supply connections.

M.1.9 Interconnected equipment

Where a group of units having individual supply connections is interconnected in such a way that it is possible for **HAZARDOUS VOLTAGE** or **HAZARDOUS ENERGY LEVELS** to be transmitted between units, a **DISCONNECT DEVICE** shall be provided to disconnect **HAZARDOUS LIVE** parts likely to be contacted while the unit under consideration is being serviced, unless these parts are guarded and marked appropriately. In addition a prominent label shall be provided on each unit giving adequate instructions for the removal of all power from the unit.

M.1.10 Multiple power sources

Where a unit receives power from more than one source (e.g. different voltages/frequencies or as redundant power), there shall be a prominent marking at each **DISCONNECT DEVICE** giving adequate instructions for the removal of all power from the unit.

If more than one such **DISCONNECT DEVICE** is provided on a unit, all these devices shall be grouped together. It is not necessary that the devices be mechanically linked.

Equipment incorporating an internal uninterruptable power supply (UPS) shall have provisions for reliably disabling the UPS and disconnecting its output prior to servicing the equipment. Instructions for disconnection of the UPS shall be provided. The internal energy source of the UPS shall be marked appropriately and guarded against accidental contact by **SERVICE PERSONNEL**.

M.2 Test methodology

Compliance is checked by inspection.

Annex N

(normative) Batteries

N.1 Requirements:

Equipment containing batteries shall be designed to reduce the risk of fire, explosion and chemical leaks under normal conditions and after a single fault in the equipment, including a fault in circuitry within the equipment battery pack. For **USER**-replaceable batteries, the design shall reduce the likelihood of reverse polarity installation if this would create a hazard.

Battery circuits shall be designed so that:

- the output characteristics of a battery charging circuit are compatible with its rechargeable battery; and
- for non-rechargeable batteries, discharging at a rate exceeding the battery manufacturer's recommendations and unintentional charging are prevented; and
- for rechargeable batteries, charging and discharging at a rate exceeding the battery manufacturer's recommendations and reversed charging are prevented.

NOTE

Reversed charging of a rechargeable battery occurs when the polarity of the charging circuit is reversed, aiding the discharge of the battery.

Under normal and abnormal operating conditions and under fault conditions

- for rechargeable batteries the charging current;
- for lithium batteries the discharging current and the reverse current

shall not exceed the permissible values given by the battery manufacturer.

Batteries shall be so mounted that the risk of the accumulation of flammable gases is minimised and that it is unlikely that the leakage of electrolyte impairs any insulation.

If equipment is provided with a replaceable battery, where the replacement of the battery with an incorrect type can result in an explosion (for example, some lithium batteries) a warning according to annex F.3.1 shall be provided.

N.2 Test methodology

For batteries compliance is checked by inspection and by evaluation of the data provided by the equipment manufacturer and battery manufacturer for charging and discharging rates.

When appropriate data is not available, compliance is checked by test. However, batteries that are inherently safe for the conditions given are not tested under those conditions.

NOTE

Consumer grade, non-rechargeable carbon-zinc or alkaline batteries are considered safe under short-circuiting conditions and therefore are not tested for discharge; nor are such batteries tested for leakage under storage conditions.

A new non-rechargeable battery or fully charged rechargeable battery provided with, or recommended by the manufacturer for use with, the equipment shall be used for each of the following tests:

- for evaluating the overcharging of a rechargeable battery, a battery is charged for a period of 7 hours under each of the following conditions in turn:
- with the battery charging circuit adjusted for its maximum charging rate (if such adjustment exists); followed by
- any single component failure that is likely to occur in the charging circuit and which would result in overcharging of the battery; and

- recharging a fully discharged rechargeable battery with one cell short-circuited, and
- for evaluating the unintentional charging of a non-rechargeable battery, a battery is charged for 7 hours with any single component failure that is likely to occur and which would result in unintentional charging of the battery; and
- for evaluating the reversed charging of a rechargeable battery, a battery is charged for 7 hours with any single component failure that is likely to occur and which would result in reversed charging of the battery; and
- for evaluating an excessive discharging rate for any battery, a battery is subjected to rapid discharge by open-circuiting or short-circuiting any current-limiting or voltage-limiting components in the load circuit of the battery under test.

Lithium batteries shall be removed from the circuit and replaced by a short-circuit when measuring currents.

NOTE

Some of the tests specified can be hazardous to the persons carrying them out; all appropriate measures to protect personnel against possible chemical or explosive hazards should be taken.

Annex P
(normative)
Table of electrochemical potentials

Magnesium, magnesium alloys	Zinc, zinc alloys	80 tin/20 Zn on steel, Zn on iron or steel	Aluminium	Cd on steel	Al/Mg alloy	Mild steel	Duralumin	Lead	Cr on steel, soft solder	Cr on Ni on steel, tin on steel 12% Cr stainless steel	High Cr stainless steel	Copper, copper alloys	Silver solder, Austenitic stainless steel	Ni on steel	Silver	Rh on Ag on Cu, silver/gold alloy	Carbon	Gold, platinum	
0	0,5	0,55	0,7	0,8	0,85	0,9	1,0	1,05	1,1	1,15	1,25	1,35	1,4	1,45	1,6	1,65	1,7	1,75	Magnesium, magnesium alloys
0	0,05	0,2	0,3	0,35	0,4	0,5	0,55	0,6	0,65	0,75	0,85	0,9	0,95	1,1	1,15	1,2	1,25		Zinc, zinc alloys
	0	0,15	0,2	0,3	0,35	0,45	0,5	0,5	0,6	0,7	0,8	0,85	0,9	1,05	1,1	1,15	1,2		80 tin/20 Zn on steel, Zn on iron or steel
		0	0,1	0,15	0,2	0,3	0,35	0,4	0,45	0,55	0,65	0,7	0,75	0,9	0,95	1,0	1,05		Aluminium
			0	0,05	0,1	0,2	0,25	0,3	0,35	0,45	0,55	0,6	0,65	0,8	0,85	0,9	0,95		Cd on steel
				0	0,05	0,15	0,2	0,2	0,3	0,4	0,5	0,55	0,6	0,75	0,8	0,85	0,9		Al/Mg alloy
					0	0,1	0,15	0,2	0,25	0,35	0,45	0,5	0,55	0,7	0,75	0,8	0,85		Mild steel
						0	0,05	0,1	0,15	0,25	0,35	0,4	0,45	0,6	0,65	0,7	0,75		Duralumin
							0	0,0	0,1	0,2	0,3	0,35	0,4	0,55	0,6	0,66	0,7		Lead
								0	0,05	0,15	0,25	0,3	0,35	0,5	0,55	0,6	0,65		Cr on steel, soft solder
									0	0,1	0,2	0,25	0,3	0,45	0,5	0,55	0,6		Cr on Ni on steel, tin on steel 12% Cr stainless steel
										0	0,1	0,15	0,2	0,35	0,4	0,45	0,5		High Cr stainless steel
											0	0,05	0,1	0,25	0,3	0,35	0,4		Copper, copper alloys
												0	0,15	0,2	0,25	0,3	0,35		Silver solder, Austenitic stainless steel
													0	0,15	0,2	0,25	0,3		Ni on steel
														0	0,5	0,1	0,15		Silver
															0	0,05	0,1		Rh on Ag on Cu, silver/gold alloy
																0	0,5		Carbon
																	0		Gold, platinum

Ag = Silver
Al = Aluminium
Cr = Chromium
Cd = Cadmium
Cu = Copper
Mg = Magnesium
Ni = Nickel
Rh = Rhodium
Zn = Zinc

Annex Q

(normative)

Measurement of creepage distances and clearances

The methods of measuring **CREEPAGE DISTANCES** and **CLEARANCES** which are specified in the following figures are used in interpreting the requirements of this standard.

Distances given are for **POLLUTION DEGREE 2**. Distance for **POLLUTION DEGREE 1** is $\frac{1}{4}$ of distance, for **POLLUTION DEGREE 3** is 1,5 times higher.

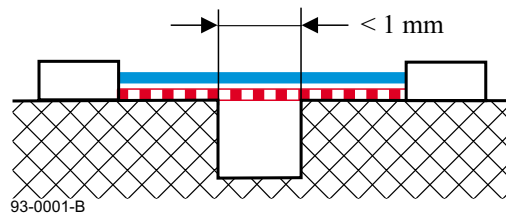

Condition: Path under consideration includes a parallel or converging-sided groove of any depth with width less than 1 mm.
Rule: **CREEPAGE DISTANCE** and **CLEARANCE** are measured directly across the groove.

Figure Q.1 - Narrow groove

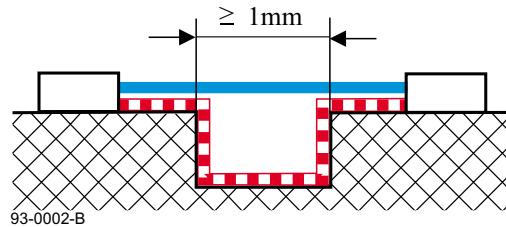

Condition: Path under consideration includes a parallel-sided groove of any depth, and equal to or more than 1 mm wide.
Rule: **CLEARANCE** is the "line of sight" distance. **CREEPAGE DISTANCE** path follows the contour of the groove.

Figure Q.2 - Wide groove

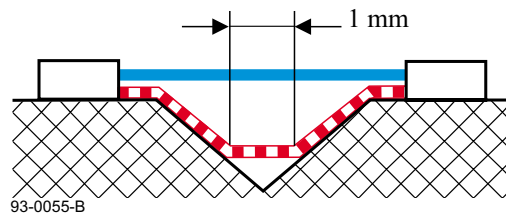

Condition: Path under consideration includes a V-shaped groove with internal angle of less than 80° and a width greater than 1 mm.
Rule: **CLEARANCE** is the "line of sight" distance. **CREEPAGE DISTANCE** path follows the contour of the groove but "short-circuits" the bottom of the groove by 1 mm link.

Figure Q.3 - V-shaped groove

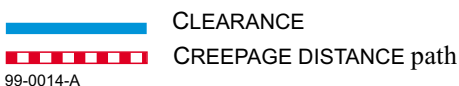

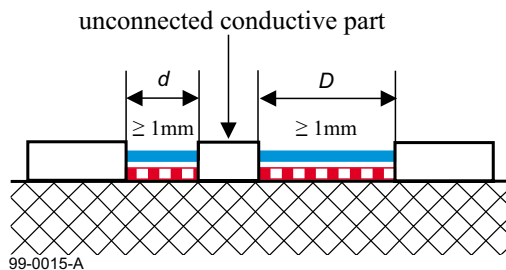

Condition: Insulation distance with intervening, unconnected conductive part.

Rule: CLEARANCE is the distance $d+D$, CREEPAGE DISTANCE is also $d+D$. Where the value of d or D is smaller than 1 mm it shall be considered as zero.

Figure Q.4 - Intervening unconnected conductive part

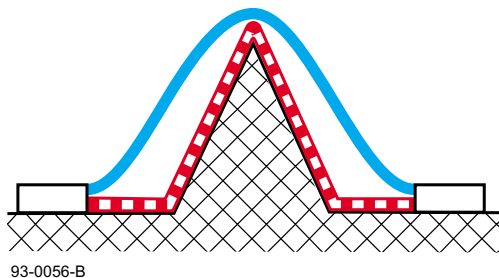

Condition: Path under consideration includes a rib.

Rule: CLEARANCE is the shortest direct air path over the top of the rib. CREEPAGE DISTANCE path follows the contour of the rib.

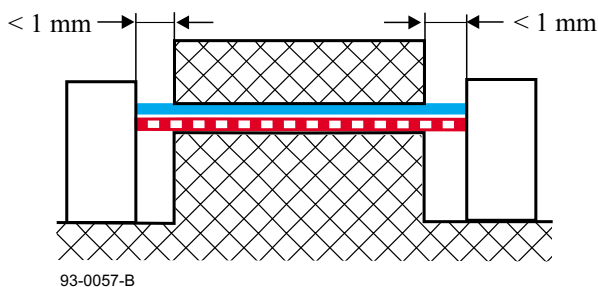

Figure Q.5 - Rib



Condition: Path under consideration includes an uncemented joint with grooves less than 1 mm wide on either side.

Rule: CLEARANCE and CREEPAGE DISTANCE path is the "line of sight" distance shown.

Figure Q.6 - Uncemented joint with narrow groove

 CLEARANCE
 CREEPAGE DISTANCE path
 99-0014-A

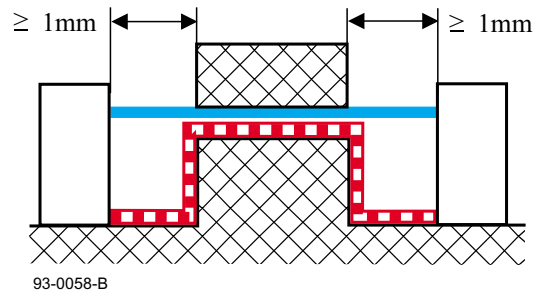

Condition: Path under consideration includes an uncemented joint with a groove equal to or more than 1 mm wide each side.
Rule: CLEARANCE is the "line of sight" distance. CREEPAGE DISTANCE path follows the contour of the groove.

Figure Q.7 - Uncemented joint with wide groove

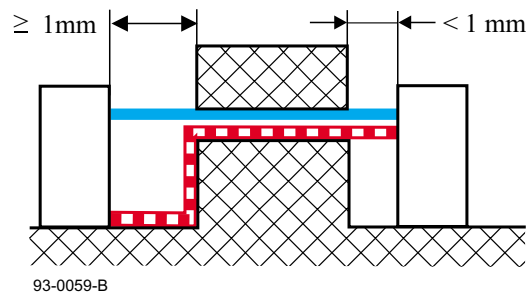

Condition: Path under consideration includes an uncemented joint with grooves on one side less than 1 mm wide, and a groove on the other equal to or more than 1 mm wide.
Rule: CLEARANCE and CREEPAGE DISTANCE path are as shown.

Figure Q.8 - Uncemented joint with narrow and wide grooves

CLEARANCE
 CREEPAGE DISTANCE path

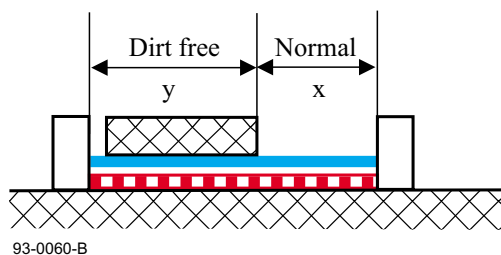

Figure Q.9 - Creepage distance under mixed conditions

To apply the **CREEPAGE DISTANCE** requirements given for dirt-free, normal or dirty situations, to a case where more than one situation exists, the limits are computed on a volt per millimetre basis according to the distance measured under each situation.

For the requirements of 3.2.2, for a working voltage of 250 V for **FUNCTIONAL INSULATION, BASIC INSULATION** and **SUPPLEMENTARY INSULATION**, material group II, the corresponding limiting volts per millimetre depend on the pollution degree as follows:

- **POLLUTION DEGREE 1:** 150 V/mm
- **POLLUTION DEGREE 2:** 138 V/mm
- **POLLUTION DEGREE 3:** 69 V/mm

The creepage distance in each situation shall be measured and the corresponding voltage computed. The sum of these computed voltages shall be not less than the **WORKING VOLTAGE** between the parts concerned.

For example:

Suppose $x = 2$ mm, then computed voltage = $2 \times 69 = 138$.

Suppose $y = 1$ mm, then computed voltage = $1 \times 138 = 138$.

The sum of these voltages is 276 and thus the example complies with the requirements for a **WORKING VOLTAGE** of 250 V.

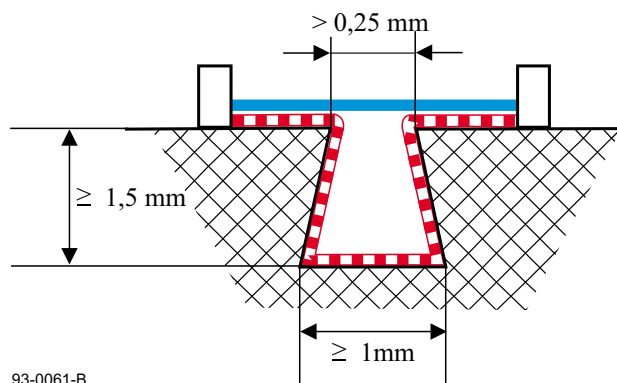

Condition: Path under consideration includes a diverging-sided groove equal to or greater than 1,5 mm deep, and greater than 0,25 mm wide at the narrowest part and equal to or greater than 1 mm at the bottom.

Rule: **CLEARANCE** is the "line of sight" distance. **CREEPAGE DISTANCE** path follows the contour of the groove. Figure Q.3 also applies to the internal corners if they are less than 80°.

Figure Q.10 - Divergent groove

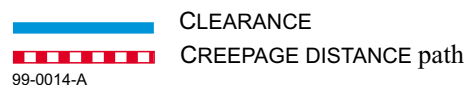

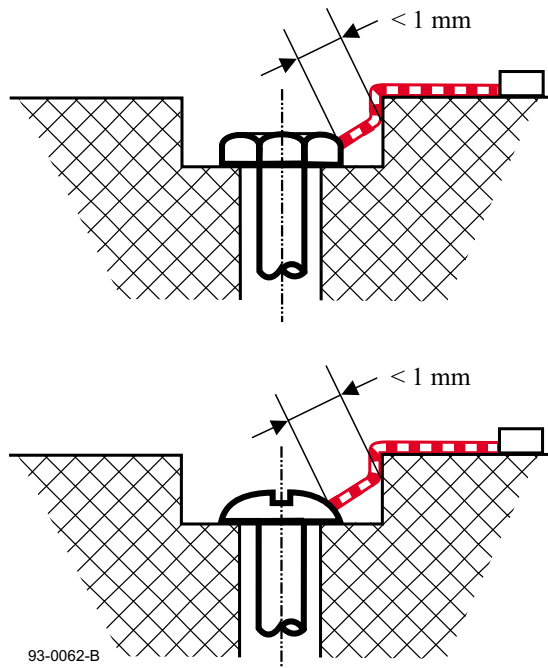

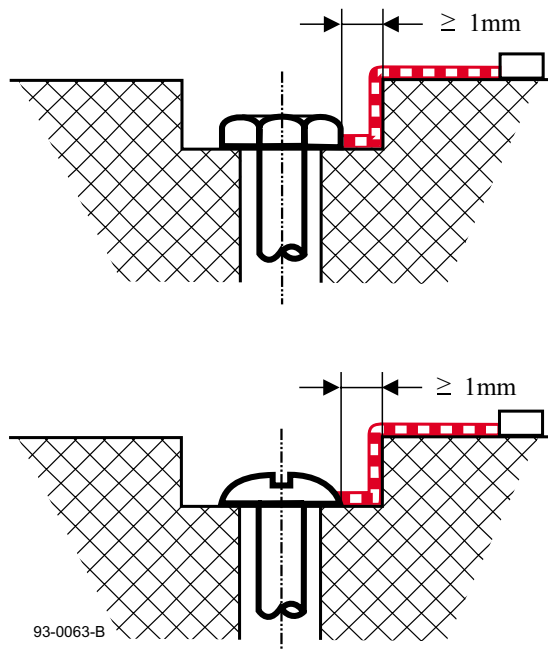

Gap between head of screw and wall of recess too narrow to be taken into account.

Figure Q.11 - Narrow recess



Gap between head of screw and wall of recess wide enough to be taken into account.

Figure Q.12 - Wide recess

-  CLEARANCE
 -  CREEPAGE DISTANCE path
- 99-0014-A

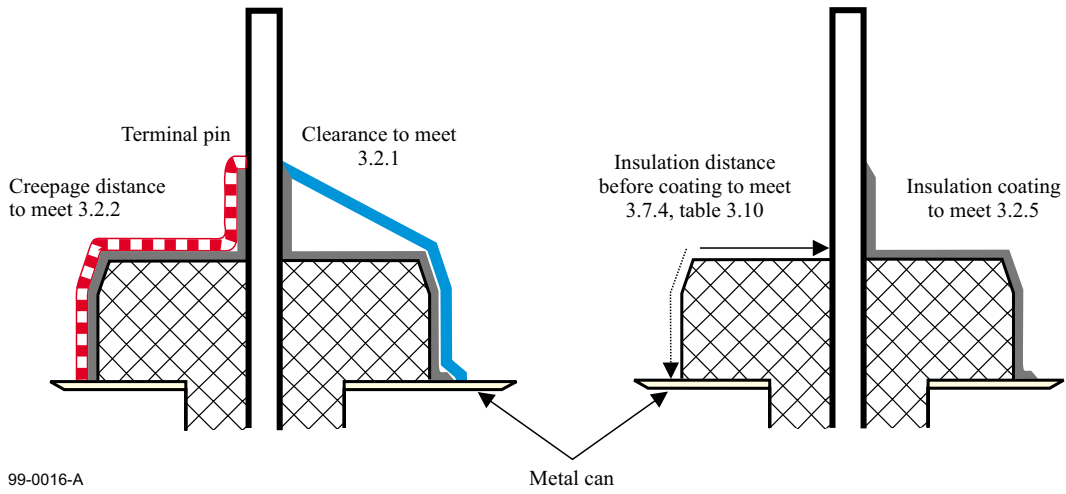

Figure Q.13 - Coating around terminals

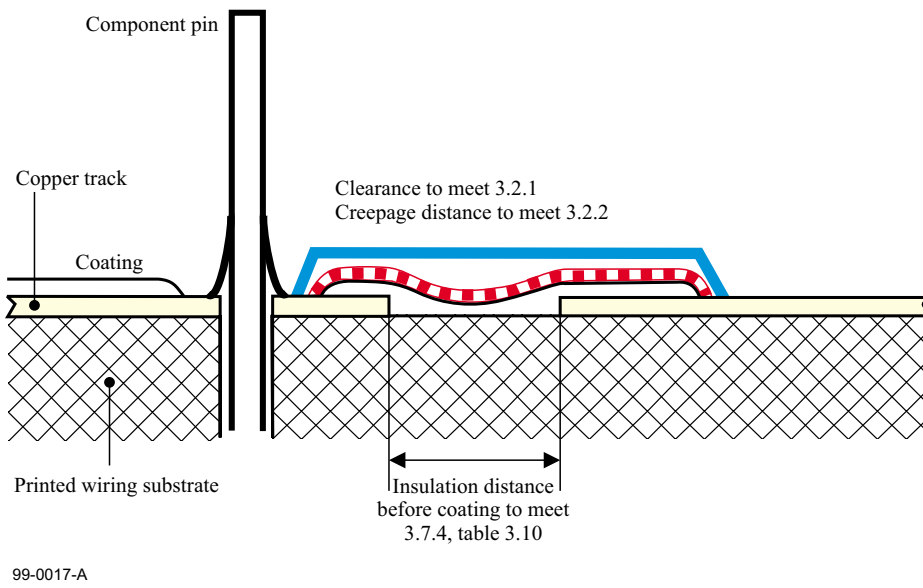
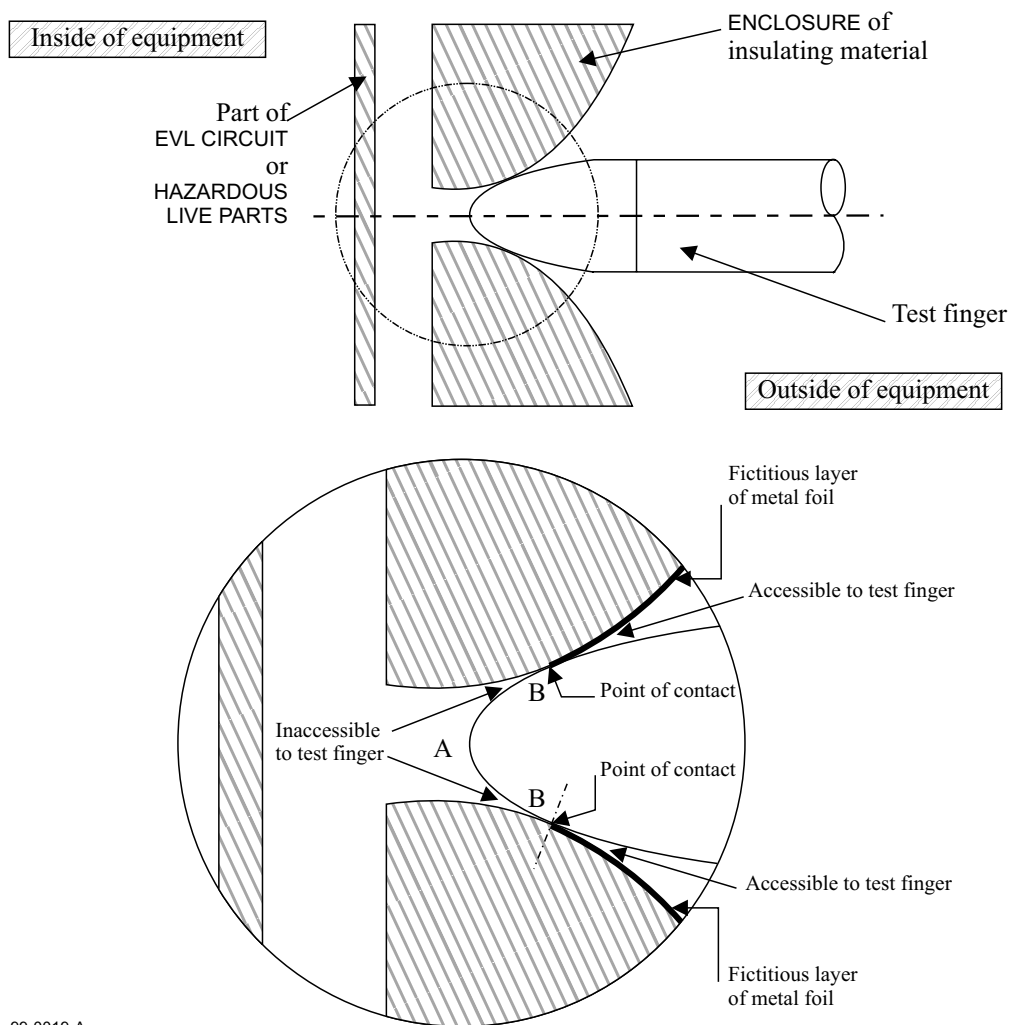

Figure Q.14 - Coating over printed wiring

— CLEARANCE
- - - CREEPAGE DISTANCE path
99-0014-A



99-0019-A

Point A is used for determining accessibility (see 3.1) -. Point B is used for measurement of **CLEARANCE** and **CREEPAGE DISTANCES**.

Figure Q.15 - Example of measurements in an enclosure of insulating material

Annex R

(normative)

Alternative method for determining minimum clearances

R.1 General

This annex contains an alternative method for determining minimum **CLEARANCES** to the method given in 3.2.1.

CLEARANCE and dielectric strength requirements are based on the expected overvoltage transients which may enter the equipment from the a.c. **MAINS**. According to IEC 60664-1, the magnitude of these transients is determined by the normal supply voltage and the supply arrangements. The latter are categorised into four groups as Overvoltage Categories I to IV. (Also known as Installation Categories I to IV) This standard normally assumes Overvoltage Category II at the equipment supply terminals.

NOTE 2

*The design of solid insulation and **CLEARANCES** should be co-ordinated in such a way that if an incident overvoltage transient exceeds the limits of Overvoltage Category II, the solid insulation can withstand a higher voltage than the **CLEARANCES**.*

R.2 Test Methodology

Compliance is checked by determining the **WORKING VOLTAGE** and installation category and measuring the **CLEARANCE**, in circuits and between circuits and accessible conductive parts, subject to the following conditions:

- For all a.c. power systems, the a.c. **MAINS** voltage in tables R.1, R.2, and R.3 is the line- to-neutral voltage.
- For a **WORKING VOLTAGE** to be used in determining **CLEARANCES** for **PRIMARY CIRCUITS** in accordance with table R.1:
 - the peak value of any superimposed ripple on a d.c. voltage, shall be included;
 - non-repetitive transients (due, for example, to atmospheric disturbances) shall not be taken into account;

NOTE

*It is assumed that any such non-repetitive transients in a **SECONDARY CIRCUIT** will not exceed the transient rating of the **PRIMARY CIRCUIT**.*

- the voltage of any **ELV CIRCUIT** or **SELV** circuit shall be disregarded;
- and in accordance with table R.2, where appropriate, for peak **WORKING VOLTAGES** exceeding the values of the a.c. **MAINS** voltage, the maximum peak **WORKING VOLTAGE** shall be used.
- The total **CLEARANCE** obtained by the use of table R.2 lie between the values required for homogeneous and non-homogeneous fields. As a result, they may not assure conformance with the appropriate dielectric strength test in case of fields which are substantially non-homogeneous.
- Use of **CLEARANCE** - Tables R.1 and R.2:

Select the appropriate column in table R.1 for the nominal a.c. **MAINS** voltage and Pollution Degree. Select the row appropriate to a **WORKING VOLTAGE** equal to the a.c. **MAINS** voltage. Note the minimum **CLEARANCE** requirement.

Go to table R.2. Select the appropriate column for the nominal a.c. **MAINS** voltage and Pollution Degree and choose the row in that column which covers the actual peak **WORKING VOLTAGE**. Read the additional **CLEARANCE** required from one of the two right hand columns and add this to the minimum **CLEARANCE** from table R.1 to give the total minimum **CLEARANCE**.

- Measurement of transient levels

The following tests are conducted only where it is expected that the transient voltages across the **CLEARANCE** in any circuit are lower than normal, due for example, to the effect of a filter in the equipment. The transient voltage across the **CLEARANCE** is measured using the following test procedure, and the **CLEARANCE** shall be based on the measured value.

During the tests, the equipment is connected to its separate power supply unit, if any, but is not connected to the **MAINS** and any surge suppressors in **PRIMARY CIRCUITS** are disconnected.

A voltage measuring device is connected across the **CLEARANCE** in question.

- To measure the reduced level of transients due to **MAINS** overvoltages, the impulse test generator of reference 2 of table D.1 is used, with U_c equal to the **MAINS** transient voltage given in the column headings of table R.1.

Three to six impulses of alternating polarity, with intervals of at least 1 s between impulses, are applied between each of the following points where relevant:

- line-to-line;
 - all line conductors joined together and neutral;
 - all line conductors joined together and protective earth;
 - neutral and protective earth.
- For a **WORKING VOLTAGE** to be used in determining **CLEARANCES** for **SECONDARY CIRCUITS** in accordance with table R.3:
 - the peak value of any superimposed ripple on a d.c. voltage, shall be included;
 - the peak value shall be used for non-sinusoidal voltages.
 - Any movable parts are placed in the most unfavourable position.
 - A force of 2 N is applied by means of a rigid test finger, test probe 11 of IEC 61032, while taking the measurements in order to simulate the potential reduction of a clearance by displacement of internal component parts,
 - A force of 30 N is applied by means of a rigid test finger, test probe 11 of IEC 61032, to the outside of conductive enclosures, in order to simulate the potential reduction of a clearance by forces occurring while handling or moving the equipment or fitting modules, etc.
 - A force of 250 N is applied to the outside of the enclosure.

When measuring the distances account shall be taken of annex Q.

R.3 Compliance criteria

During the mechanical tests the accessible parts shall not become **HAZARDOUS LIVE** unless the **HAZARDOUS LIVE** part exceeds 1 000 V a.c. or 1 500 V d.c., in which case a **CLEARANCE** equal to the value for **BASIC INSULATION** has to be maintained. After the mechanical tests the distances measured shall not be less than the appropriate values specified in table R.1 and table R.3 and where applicable the sum of the values specified in table R.1 and table R.2.

Table R.1 - Minimum clearances for insulation in primary circuits and between primary and secondary circuits (mm)

Working voltage up to and including		Nominal a.c. mains voltage ≤ 150 V (transient rating 1500 V)				Nominal a.c. mains voltage > 150 V ≤ 300 V (transient rating 2500 V)				Nominal a.c. mains voltage > 300 V ≤ 600 V (transient rating 4000 V)	
V peak or d.c.	V r.m.s. (sinusoidal)	Pollution degrees 1 and 2		Pollution degree 3		Pollution degrees 1 and 2		Pollution degree 3		Pollution degrees 1, 2 and 3	
		B/S	R	B/S	R	B/S	R	B/S	R	B/S	R
71 V	50 V	1,0 (0,5)	2,0 (1,0)	1,3 (0,5)	2,6 (1,6)	2,0 (1,5)	4,0 (3,0)	2,0 (1,5)	4,0 (3,0)	3,2 (3,0)	6,4 (6,0)
210 V	150 V	1,0 (0,5)	2,0 (1,0)	1,3 (0,8)	2,6 (1,6)	2,0 (1,5)	4,0 (3,0)	2,0 (1,5)	4,0 (3,0)	3,2 (3,0)	6,4 (6,0)
420 V	300 V	B/S 2,0 (1,5) R 4,0 (3,0)								3,2 (3,0)	6,4 (6,0)
840 V	600 V	B/S 3,2 (3,0) R 6,4 (6,0)									
1 400 V	1 000 V	B/S 4,2 R 6,4									
2 800 V	2 000 V	B/S/R 8,4									
7 000 V	5 000 V	B/S/R 17,5									
9 800 V	7 000 V	B/S/R 25									
14 000 V	10 000 V	B/S/R 37									
28 000 V	20 000 V	B/S/R 80									
42 000 V	30 000 V	B/S/R 130									

- The values in the table are applicable to **BASIC INSULATION (B)**, **SUPPLEMENTARY INSULATION (S)** and **REINFORCED INSULATION (R)**.
- The values in parenthesis are applicable to **BASIC INSULATION**, **SUPPLEMENTARY INSULATION** or **REINFORCED INSULATION** only if manufacturing is subjected to a quality control programme. In particular, **DOUBLE INSULATION** and **REINFORCED INSULATION** shall be subjected to routine testing for dielectric strength.
- For **WORKING VOLTAGES** between 420 V peak or d.c. and 42 000 V peak or d.c., linear interpolation is permitted between the nearest two points, the calculated value being rounded up to the higher 0,1 mm increment.

Table R.2 - Additional clearances for insulation in primary circuits with peak working voltages exceeding the peak value of the nominal a.c. mains voltage

Nominal a.c. mains voltage ≤ 150 V		Nominal a.c. mains voltage >150 V ≤ 300 V	Additional clearance	
Pollution degrees 1 and 2	Pollution degree 3	Pollution degrees 1, 2 and 3	Basic insulation or supplementary insulation	Reinforced insulation
Maximum peak working voltage	Maximum peak working voltage	Maximum peak working voltage		
210 V (210 V)	210 V (210 V)	420 V (420 V)	0	0
298 V (288 V)	294 V (293 V)	493 V (497 V)	0,1 mm	0,2 mm
386 V (366 V)	379 V (376 V)	567 V (575 V)	0,2 mm	0,4 mm
474 V (444 V)	463 V (459 V)	640 V (652 V)	0,3 mm	0,6 mm
562 V (522 V)	547 V (541 V)	713 V (729 V)	0,4 mm	0,8 mm
650 V (600 V)	632 V (624 V)	787 V (807 V)	0,5 mm	1,0 mm
738 V (678 V)	715 V (707 V)	860 V (884 V)	0,6 mm	1,2 mm
826 V (756 V)	800 V (790 V)	933 V (961 V)	0,7 mm	1,4 mm
914 V (839 V)		1 006 V (1 039 V)	0,8 mm	1,6 mm
1 002 V (912 V)		1 080 V (1 116 V)	0,9 mm	1,8 mm
1 090 V (990 V)		1 153 V (1 193 V)	1,0 mm	2,0 mm
		1 226 V (1 271 V)	1,1 mm	2,2 mm
		1 300 V (1 348 V)	1,2 mm	2,4 mm
		(1 425 V)	1,3 mm	2,6 mm

The values in parentheses shall be used when the values in parentheses in table R.1 are used in accordance with note 2 of table R.1.

For **PRIMARY CIRCUITS** operating on nominal **MAINS** voltage up to 300 V, where the repetitive peak voltage in the circuit exceeds the peak value of the **MAINS** voltage, the minimum **CLEARANCE** shall be the sum of the value from table R.1, for a working voltage equal to the **MAINS** voltage and the appropriate additional **CLEARANCE** value from table R.2.

NOTE

*Table R.2 is applicable to equipment that will not be subjected to transients exceeding Overvoltage Category II according to IEC 60664-1. The appropriate transient ratings are given in parentheses in each nominal a.c. **MAINS** voltage column. If higher transients are expected, additional protection might be necessary in the supply to the equipment or in the installation.*

Table R.3 - Minimum clearances in secondary circuits

Working voltage up to and including		Nominal a.c. mains voltage ≤ 150 V (transient rating for secondary circuit 800 V) (see 5)				Nominal a.c. mains voltage > 150 V ≤ 300 V (transient rating for secondary circuit 1500 V) (see 5)				Nominal a.c. mains voltage > 150 V ≤ 600 V (transient rating for secondary circuit 2500 V) (see 5)		Circuits not subject to transient overvoltages (see item 4)		
V peak or d.c.	V r.m.s. (sinusoidal)	Pollution degree 1 and 2		Pollution degree 3		Pollution degree 1 and 2		Pollution degree 3		Pollution degree 1, 2 and 3		Pollution degree 1 and 2 only		
V	V	B/S	R	B/S	R	B/S	R	B/S	R	B/S	R	B/S	R	
71	50	0,7 (0,2)	1,4 (0,4)	1,3 (0,8)	2,6 (1,6)	1,0 (0,5)	2,0 (1,0)	1,3 (0,8)	2,6 (1,6)	2,0 (1,5)	4,0 (3,0)	0,4 (0,2)	0,8 (0,4)	
140	100	0,7 (0,2)	1,4 (0,4)	1,3 (0,8)	2,6 (1,6)	1,0 (0,5)	2,0 (1,0)	1,3 (0,8)	2,6 (1,6)	2,0 (1,5)	4,0 (3,0)	0,7 (0,2)	1,4 (0,4)	
210	150	0,9 (0,2)	1,8 (0,4)	1,3 (0,8)	2,6 (1,6)	1,0 (0,5)	2,0 (1,0)	1,3 (0,8)	2,6 (1,6)	2,0 (1,5)	4,0 (3,0)	0,7 (0,2)	1,4 (0,4)	
280	200	B/S 1,4 (0,8) R 2,8 (1,6)									2,0 (1,5)	4,0 (3,0)	1,1 (0,2)	2,2 (0,4)
420	300	B/S 1,9 (1,0) R 3,8 (2,0)									2,0 (1,5)	4,0 (3,0)	1,4 (0,2)	2,8 (0,4)
700	500	B/S 2,5 R 5,0												
840	600	B/S 2,7 R 6,0												
1 400	1000	B/S 4,2 R 8,0												
3 000	2 000	B/S/R 8,4 see item 6												
7 000	5 000	B/S/R 8,4 see item 6												
9 800	7 000	B/S/R 8,4 see item 6												
14 000	10 000	B/S/R 8,4 see item 6												
28 000	20 000	B/S/R 8,4 see item 6												
42 000	30 000	B/S/R 8,4 see item 6												

1) The values in the table are applicable to **BASIC INSULATION (B)**, **SUPPLEMENTARY INSULATION (S)** and **REINFORCED INSULATION (R)**.

2) The values in parenthesis are applicable to **BASIC INSULATION**, **SUPPLEMENTARY INSULATION** or **REINFORCED INSULATION** only if manufacturing is subjected to a quality control programme. In particular, **DOUBLE INSULATION** and **REINFORCED INSULATION** shall be subjected to routine testing for dielectric strength.

3) For **WORKING VOLTAGES** between 420 V peak or d.c. and 42000 V peak or d.c., linear interpolation is permitted between the nearest two points, the calculated value being rounded up to the higher 0,1 mm increment.

4) The values are applicable to d.c. **SECONDARY CIRCUITS** which are reliably connected to earth and have capacitive filtering which limits the peak-to-peak ripple to 10 % of the d.c. voltage.

5) Where transients in the equipment exceed this value, the appropriate higher clearance shall be used.

6) Compliance with a **CLEARANCE** value of 8,4 mm or greater is not required if the **CLEARANCE** path is:

- entirely through air; or
- wholly or partly along the surface of an insulating material of Material group I; and the insulation involved passes an dielectric strength test according to 3.2.3.1.3 using:
 - an a.c. test voltage whose r.m.s. value is equal to 1,06 times the peak **WORKING VOLTAGE**; or
 - a d.c. test voltage equal to the peak value of the a.c. test voltage prescribed above.

If the clearance path is partly along the surface of a material that is not Material Group I, the dielectric strength test is conducted across the air gap only.

Annex S

(normative)

Limiting the available current and energy

S.1 General

A **MAINS** operated limited power source, or a battery operated limited power source that is recharged from the **MAINS** while supplying the load, shall incorporate an isolating transformer.

A limited power source shall comply with one of the following:

- the output is inherently limited in compliance with table S.1; or
- an impedance limits the output in compliance with table S.1. If a Positive Temperature Coefficient device is used, it shall pass the tests specified in IEC 60730-1, clauses 15 and 17, and IEC 60730-1, clauses J15 and J17; or
- an overcurrent protective device is used and the output is limited in compliance with table S.2; or
- a regulating network limits the output in compliance with table S.1, both under **NORMAL OPERATING CONDITIONS** and abnormal operating conditions in the regulating network (open circuit or short-circuit); or
- a regulating network limits the output in compliance with table S.1 under **NORMAL OPERATING CONDITIONS**, and an overcurrent protective device limits the output in compliance with table S.2 under any abnormal operating condition in the regulating network (open-circuit or short-circuit).

Where an overcurrent protective device is used, it shall be a fuse or a non-adjustable, non-autoreset electromechanical device.

S.2 Test methodology

Compliance is checked by inspection and the appropriate circuit output test. The measurements shall include both open circuit voltage measurement and short circuit measurements. The point of maximum VA shall also be measured in each case.

Where the current is limited by either regulating network or an overcurrent protective device is used, the test shall also take into account abnormal operating conditions within the network and each individual protective device.

Table S.1 - Limits for inherently limited power sources

Output voltage ¹⁾ (U_{oc})		Output current ²⁾ (I_{sc})	VA ³⁾ (V x A)
a.c.	d.c.	A	(V x A)
< 20 V	≤ 20 V	≤ 8,0 A	≤ 5 x U_{oc}
20 V < U_{oc} < V 30	20 V < U_{oc} ≤ 30 V	≤ 8,0 A	≤ 100
-	30 V < U_{oc} ≤ 60 V	≤ 150 / U_{oc}	≤ 100

Conditions applicable to table S.1

- 1) U_{oc} : Output voltage measured in accordance with B.4.2 with all load circuits disconnected. Voltages are for sinusoidal a.c. and ripple-free d.c. For non-sinusoidal a.c., and for d.c. with ripple greater than 10% peak, the peak voltage shall not exceed 42,4 V.
- 2) I_{sc} : Maximum output current after 60 s of operation with any non-capacitive load, including short-circuit.
- 3) VA: Maximum output VA with any load. Initial transients lasting less than 100 ms are ignored.

**Table S.2 - Limits for power sources not inherently limited
(overcurrent protective device required)**

Output voltage ¹⁾ (U_{oc})		Output current ²⁾ (I_{sc})	VA ³⁾	Rated current value of overcurrent protective device ⁴⁾
a.c.	d.c.			
< 20 V	< 20	≤ 1000 U_{oc} A	≤ 250 (V x A)	≤ 5,0 A
20 V < U_{oc} ≤ 30	20 V < U_{oc} ≤ 30 V			≤ 100 / U_{oc} A
-	30 V < U_{oc} ≤ 60 V			≤ 100 / U_{oc} A

Conditions applicable to table S.2

- 1) U_{oc} : Output voltage measured in accordance with B.4.2 with all load circuits disconnected. Voltages are for sinusoidal a.c. and ripple-free d.c. For non- sinusoidal a.c., and for d.c. with ripple greater than 10% peak, the peak voltage shall not exceed 42,4 V.
- 2) I_{sc} : Maximum output current after 60 s of operation with any non-capacitive load, including short-circuit, and with any overcurrent protective devices bypassed.
- 3) VA : Maximum output VA with any load and with overcurrent protective devices bypassed. Initial transients lasting less than 100 ms are ignored.
- 4) The rated current values of overcurrent protective devices are based on fuses and circuit-breakers that break the circuit within 120 s with a current equal to 210% of the rated current value specified in the table.

Annex T

(normative)

Distance from potential ignition sources

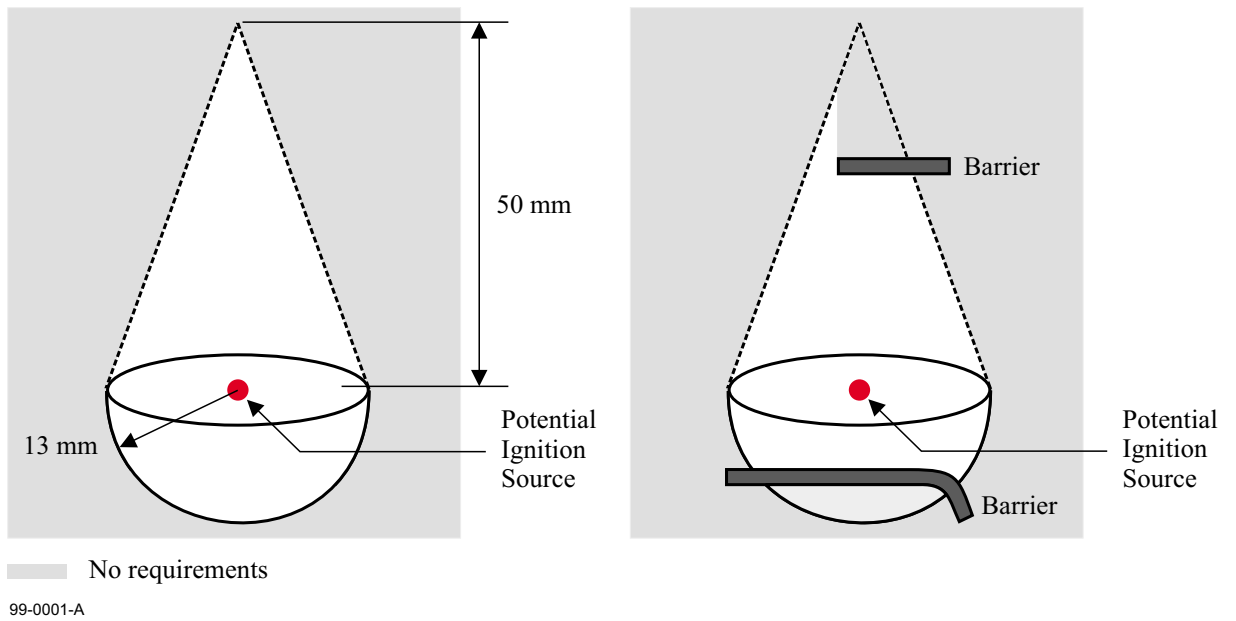

Annex U

(normative)

Tests for resistance to heat and fire

NOTE

Toxic fumes may be given off during the tests. Where appropriate the tests should be carried out either under a ventilated hood or in a well-ventilated room, but free from draughts which could invalidate the tests.

U.1 Flammability test for fire enclosures of transportable equipment having a total mass exceeding 18 kg, and of stationary equipment

U.1.1 Samples

Three samples, each consisting of either a complete fire enclosure or a section of the fire enclosure representing the thinnest significant wall thickness and including any ventilation opening, are tested.

U.1.2 Conditioning of samples

Prior to being tested, the samples are conditioned in a circulating air oven for a period of 7 days (168 h), at a temperature 10 K higher than the maximum temperature reached by the material measured during the test of 5.3.1.2 or 70°C, whichever is the higher, and then cooled to room temperature.

U.1.3 Mounting of samples

Samples are mounted as they would be in actual use. A layer of untreated surgical cotton is located 300 mm below the point of application of the test flame.

U.1.4 Test flame

The test flame according to IEC 60695-11-3 shall be used.

U.1.5 Test procedure

The test flame is applied to an inside surface of the sample, at a location judged to be likely to become ignited because of its proximity to a source of ignition. If a vertical part is involved, the flame is applied at an angle of approximately 20° from the vertical. If ventilation openings are involved, the flame is applied to an edge of an opening, otherwise to a solid surface. In all cases, the tip of the inner blue cone is to be in contact with the sample. The flame is applied for 5 s and removed for 5 s. This operation is repeated until the sample has been subjected to five applications of the test flame to the same location.

The test is repeated on the remaining two samples. If more than one part of the fire enclosure is near a source of ignition, each sample is tested with the flame applied to a different location.

U.1.6 Compliance criteria

During the test, the sample shall not release either flaming drops or particles capable of igniting the surgical cotton. The sample shall not continue to burn for more than 1 min after the fifth application of the test flame, and shall not be consumed completely.

U.2 Flammability test for fire enclosures of transportable equipment having a total mass not exceeding 18 kg, and for material and components located within fire enclosures

U.2.1 Samples

Three samples are tested. For fire enclosures, each sample consists of either a complete fire enclosure or a section of the fire enclosure representing the thinnest significant wall thickness and including any ventilation opening. For material to be located within the fire enclosure, each sample of the material consists of one of the following:

- the complete part; or
- a section of the part representing the thinnest significant wall thickness; or

- a test plaque or bar of uniform thickness representing the thinnest significant section of the part.

For components to be located within the fire enclosure, each sample is to be a complete component.

U.2.2 Conditioning of samples

Prior to being tested, the samples are conditioned in a circulating air oven for a period of 7 days (168 h), at a temperature 10 K higher than the maximum temperature of the part measured during the test of 5.1 or 70°C, whichever is the higher, and then cooled to room temperature.

U.2.3 Mounting of samples

Samples are mounted and oriented as they would be in actual use according to the manufacturers instructions..

U.2.4 Test flame

The test flame according to IEC 60695-11-4 shall be used.

U.2.5 Test procedure

The test flame is applied to an inside surface of the sample at a point judged to be likely to become ignited because of its proximity to a source of ignition. For the evaluation of materials located within the fire enclosure, it is permitted to apply the test flame to an external surface of the sample. For the evaluation of components to be located within the fire enclosure, the test flame is applied directly to the component.

If a vertical part is involved, the flame is applied at an angle of approximately 20° from the vertical. If ventilation openings are involved, the flame is applied to an edge of an opening, otherwise to a solid surface. In all cases, the tip of the flame is to be in contact with the sample. The flame is applied for 30 s and removed for 60 s, then reapplied to the same location for 30 s. The test is repeated on the remaining two samples. If any part being tested is near (“near” need to be clarified) a source of ignition at more than one point, each sample is tested with the flame applied to a different point which is near a source of ignition.

U.2.6 Compliance criteria

During the test, the samples shall not continue to burn for more than 1 min after the second application of the test flame, and shall not be consumed completely.

U.2.7 Alternative test

As an alternative to the apparatus and procedure specified in U.2.4 and U.2.5, it is permitted to use the apparatus and procedure specified in clauses 4 and 8 of IEC 60695-2-2: 1980. The manner, duration and number of flame applications are as specified in U.2.5 and compliance is in accordance with U.2.6.

NOTE

Compliance with the method of either U.2.4 and U.2.5 or of U.2.7 is acceptable; it is not required to comply with both methods.

U.3 Flammability tests for the bottom of fire enclosures

U.3.1 Mounting of samples

A sample of the complete finished bottom of the **FIRE ENCLOSURE** is securely supported in a horizontal position. Bleached cheesecloth of approximately 40 g/m² is placed in one layer over a shallow, flat-bottomed pan approximately 50 mm below the sample, and is of sufficient size to cover completely the pattern of openings in the sample, but not large enough to catch any of the oil that runs over the edge of the sample or otherwise does not pass through the openings.

NOTE

Use of a metal screen or a wired-glass enclosure surrounding the test area is recommended.

U.3.2 Test procedure

A small metal ladle (preferably no more than 65 mm in diameter), with a pouring lip and a long handle whose longitudinal axis remains horizontal during pouring, is partially filled with 10 ml of a distillate fuel oil which is a medium volatile distillate having a mass per unit volume between 0,845 g/ml and 0,865 g/ml, a flash point between 43,5°C and 93,5°C and an average calorific value of 38 MJ/l. The ladle

containing the oil is heated and the oil ignited and permitted to burn for 1 min, at which time all of the hot flaming oil is poured at the rate of approximately 1 ml/s in a steady stream onto the centre of the pattern of openings, from a position approximately 100 mm above the openings.

The test is repeated twice at 5 min intervals, using clean cheesecloth.

U.3.3 Compliance criteria

During these tests the cheesecloth shall not ignite.

U.4 Flammability test for high voltage cables

Compliance of cables and insulation of wires is checked according to IEC 60695-2-2.

For the purpose of this standard, the following applies with regard to IEC 60695-2-2.

Clause 5 – Severities

The values of duration of the application of the test flame are as follows:

- first specimen: 10 s
- second specimen: 60 s
- third specimen: 120 s

Clause 7 – Initial measurements

Not applicable

Clause 8 – Test procedure

- Add the following to 8.4:

The burner is supported so that its axis is in an angle of 45° to the vertical. The cable or wire is held in an angle of 45° to the vertical, its axis being in a vertical plane perpendicular to the vertical plane containing the axis of the burner.

- Subclause 8.5 is replaced by the following:

The test is made on three specimens taken from each type of cable or wire as used in the equipment, for example with additional screening and sleeves.

Clause 9 – Observations and measurements

- Subclause 9.1

Not applicable.

- Subclause 9.2

The second paragraph is replaced by the following:

Duration of the burning denotes the time interval from the moment the test flame is removed until any flame has extinguished.

Clause 10 – Evaluation of the results

- The existing text is replaced by the following:

During the test, any burning of the insulating materials shall be steady and shall not spread appreciably. Any flame shall self-extinguish in 30 s from the removal of the test flame.

U.5 Flammability classification of materials

Materials are classified according to the burning behaviour and their ability to extinguish, if ignited.

Foamed materials, tested in the thinnest significant thickness used:

Class			ISO standard	Replacing previously used class
FH-1	regarded better than	FH-2	9772	HF-1
FH-2	regarded better than	FH-3	9772	HF-2
FH-3			9772	HF-3

Rigid (engineering structural) foamed materials, tested in the thinnest significant thickness used.

Class			IEC standard	Replacing previously used class
5VA	regarded better than	5VB	6069511-20	5V
5VB	regarded better than	V-0	6069511-20	5V
V-0	regarded better than	V-1	6069511-10	-
V-1	regarded better than	V-2	6069511-10	-
V-2	regarded better than	HB40	6069511-10	-
HB40	regarded better than	HB75	6069511-10	HB
HB75			6069511-10	HB

VTM materials, tested in the thinnest significant thickness used.

Class			ISO standard	Comparable, only with respect to flammability
VTM-0	regarded better than	VTM-1	9773	V-0
VTM-1	regarded better than	VTM-2	9773	V-1
VTM-2			9773	-

In the case VTM materials are used, also relevant electrical and mechanical requirements should be considered.

Annex V

(normative) Tests for enclosures

V.1 Steady force test, 30 N

ENCLOSURES or parts thereof, and barriers are subjected to a steady force of $30\text{ N} \pm 3\text{ N}$ for a period of 5 s applied by means of the rigid test finger, test probe 11 of IEC 61032. This test may be applied on the complete equipment or on a separate sub-assembly.

V.2 Impact test

External surfaces of **ENCLOSURES**, the failure of which would give access to hazardous rotating or otherwise moving parts, are tested as follows:

A sample consisting of the complete **ENCLOSURE** or a portion thereof, representing the largest un-reinforced area is supported in its normal position. A solid, smooth, steel sphere, approximately 50 mm in diameter and with a mass of $500\text{ g} \pm 25\text{ g}$, is used to perform the following tests:

- On horizontal surfaces, the sphere is permitted to fall freely from rest through a vertical distance of 1300 mm onto the sample, see figure V.1.

This test is not applied to the platen glass of equipment (e.g. copying machines).

- On vertical surfaces, the sphere is suspended by a cord and swung as a pendulum in order to apply a horizontal impact, dropping through a vertical distance of 1300 mm onto the sample, see figure 3.

Alternatively it is permitted to simulate horizontal impacts on vertical or sloping surfaces by mounting the sample at 90° to its normal position and applying the vertical impact test instead of the pendulum test. This test does not apply to **ENCLOSURES** of **TRANSPORTABLE EQUIPMENT** and of equipment intended to be held in the hand when operating.

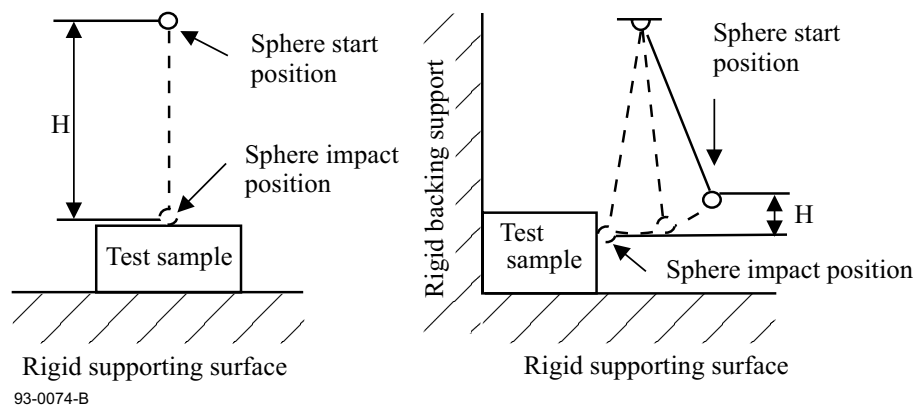

93-0074-B

Figure V.1 - Impact test using sphere

Annex W

(normative)

Mechanical strength of CRTs and protection against the effects of implosion

W.1 General requirements

CRTs with a maximum face dimension exceeding 160 mm either shall be intrinsically protected with respect to effects of implosion and to mechanical impact, or the enclosure of the equipment shall provide adequate protection against the effects of an implosion of the CRT.

A non-intrinsically protected CRT shall be provided with an effective protective screen which cannot be removed by hand. If a separate screen of glass is used, it shall not be in contact with the surface of the CRT.

W.1.1 Test methodology

Compliance is checked by inspection, by measurement, and by the following tests:

- W.1.1.1 for intrinsically protected CRTs, including those having an integral protective screen;
- W.1.1.2 for equipment having non-intrinsically protected CRTs.

NOTE 1

A CRT is considered to be intrinsically protected with respect to the effects of implosion if, when it is correctly mounted, no additional protection is necessary.

NOTE 2

To facilitate the tests, the CRT manufacturer may indicate the most vulnerable area on the CRTs to be tested.

W.1.1.1 Intrinsically protected CRT's, including those having integral protective screens

Each of the tests of W.1.1.4 and W.1.1.5 is made on six CRTs, three of which are tested as received and the others after having been subjected to the ageing process of W.1.1.3.

For the tests of W.1.1.4 and W.1.1.5, the CRTs are mounted in a test cabinet, according to the instructions given by the manufacturer of the CRT, the cabinet being placed on a horizontal support at a height of 75 cm \pm 5 cm above the floor.

Care is taken that, during the tests, the cabinet does not slide on the support.

NOTE

The following description of a test cabinet is given as an example:

- *the cabinet is made of plywood, with a thickness of about 12 mm for CRTs having a maximum face dimension not exceeding 50 cm and of about 19 mm for larger CRTs;*
- *the outside dimensions of the cabinet are approximately 25 % larger than the overall dimensions of the CRT;*
- *the front of the cabinet is provided with an opening closely surrounding the CRT when mounted. The back of the cabinet is provided with an opening, 5 cm in diameter, and rests against a wooden bar, about 25 mm high, which is fixed to the support and prevents the cabinet from sliding.*

W.1.1.2 Non-intrinsically protected CRTs

The equipment, with the CRT and the protective screen in position, is placed on a horizontal support at a height of 75 cm \pm 5 cm above the floor, or directly on the floor if the equipment is obviously intended to be positioned on the floor.

The CRT is made to implode inside the enclosure of the equipment by the method described in W.1.1.4.

W.1.1.3 Ageing process

The ageing process is as follows:

a) Damp heat conditioning:

- 24 h at (25 ± 2) °C and 90 % to 95 % relative humidity
- 24 h at (45 ± 2) °C and 75 % to 80 % relative humidity
- 24 h at (25 ± 2) °C and 90 % to 95 % relative humidity

b) Change of temperature consisting of two cycles, each comprising:

- 1 h at $(+20 \pm 2)$ °C
- 1 h at (-25 ± 2) °C
- 1 h at $(+20 \pm 2)$ °C
- 1 h at $(+50 \pm 2)$ °C

NOTE

The change of temperature is not intended to cause severe thermal stress on the CRT, and may be achieved using one or two chambers.

c) Damp heat conditioning as indicated under a).

W.1.1.4 Implosion test

Cracks are propagated in the envelope of each CRT by the following method:

An area on the side or on the face of each CRT is scratched (see figure W.1) with a diamond stylus and this place is repeatedly cooled with liquid nitrogen or the like until a fracture occurs. To prevent the cooling liquid from flowing away from the test area, a dam of modelling clay or the like should be used.

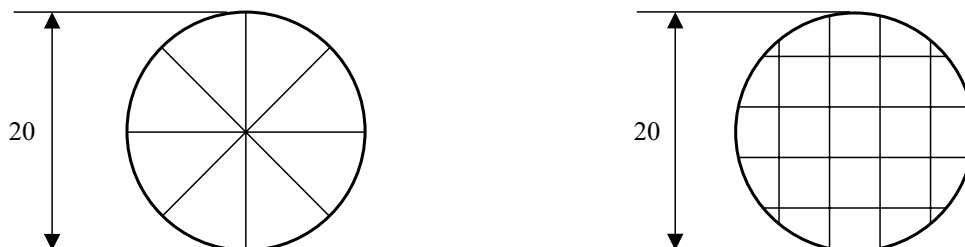

Dimensions in millimetres

99-0018-A

Dimensions in millimetres

Figure W.1 – Scratch patterns for implosion test

Compliance criteria

After this test, no particles having a mass exceeding 2 g shall have passed a 25 cm high barrier placed on the floor 50 cm from the projection of the front of the CRT and no particles shall have passed a similar barrier at 200 cm.

W.1.1.5 Mechanical strength test

Each CRT is subjected to one impact of a hardened steel ball having a Rockwell hardness of at least R62 and a diameter of 40^{+1}_0 mm, and which is suspended from a fixed point by means of a string.

Keeping the string straight, the ball is raised and then allowed to fall onto any place on the face of the CRT from a height such that the vertical distance between the ball and the point of impact is:

- 210 cm for CRTs having a maximum face dimension exceeding 40 cm;

- 170 cm for other CRTs.

The point of impact on the face of the CRT shall be at least 20 mm from the border of its useful area.

Compliance criteria

After this test, no particles having a mass exceeding 10 g shall have passed a 25 cm high barrier, placed on the floor, 150 cm from the projection of the front of the CRT.

W.1.2 Compliance criteria

All samples of intrinsically protected CRTs, including those having integral protective screens shall pass the tests of W.1.1.4 and W.1.1.5.

Non-intrinsically protected CRTs shall pass the test of W.1.1.4.

Free printed copies can be ordered from:

ECMA

114 Rue du Rhône
CH-1204 Geneva
Switzerland

Fax: +41 22 849.60.01
Email: documents@ecma.ch

or from

EACEM

140, Avenue Louise
B-1050 Bruxelles
Belgium

Fax: +32-2-640.44.09
Email: info@eacem.be

Files of this standard can be freely downloaded from the ECMA web site (www.ecma.ch) or from the EACEM web site (www.eacem.be). These sites give full information on ECMA and EACEM.

ECMA
114 Rue du Rhône
CH-1204 Geneva
Switzerland

EACEM
140, Avenue Louise
B-1050 Bruxelles
Belgium

See inside cover page for obtaining further soft or hard copies.