

ECMA

Standardizing Information and Communication Systems

**Private Integrated Services Network
(PISN) -
Profile Standard for the Use of PSS1
(QSIG) in Air Traffic Services
Networks**



Standardizing Information and Communication Systems

**Private Integrated Services Network
(PISN) -
Profile Standard for the Use of PSS1
(QSIG) in Air Traffic Services
Networks**

Brief History

This Standard is one of a series of ECMA Standards defining services and signalling protocols applicable to Private Integrated Services Networks (PISNs). The series uses ISDN concepts as developed by ITU-T and conforms to the framework of International Standards for Open Systems Interconnection as defined by ISO/IEC. It has been produced under ETSI work item DEN/ECMA-00189.

This Standard specifies the functional profile for interconnecting Private Integrated services Network eXchanges (PINX) in Air Traffic Services (ATS) PISNs to permit interoperability between equipment from different vendors.

This Standard is based upon the practical experience of ECMA member companies and the results of their active and continuous participation in the work of ISO/IEC JTC1, ITU-T, ETSI and other international and national standardization bodies. It represents a pragmatic and widely based consensus.

This ECMA Standard is envisaged for contribution to ETSI for adoption as an EN.

This ECMA Standard has been adopted by the General Assembly of June 2000.

Table of contents

1	Scope	1
2	Conformance	1
3	References (normative)	1
4	Definitions	2
4.1	External definitions	2
5	List of acronyms	3
6	Specification framework	4
6.1	General	4
6.2	Terminal Equipment (TE)	5
6.3	Private Termination System (PTS)	5
6.4	Switching (SW)	5
6.5	Mapping (MP)	5
6.6	Call Control (CC)	5
7	Physical interface and protocol stack at the C reference point	6
8	Switching (SW) functions	6
8.1	Speech compression	6
9	Mapping (MP) functions	6
9.1	Physical layer functions	6
9.1.1	Physical and electrical interface requirements	7
9.1.2	Rate adaptation and sub-multiplexing	7
9.1.3	Alarm Indication Signal (AIS)	7
9.1.4	Synchronisation	7
9.2	Data link layer functions	7
9.2.1	General procedures	7
9.2.2	System parameters	8
9.3	Octet synchronisation procedure	8
10	Call Control (CC) functions - End PINX case	8
10.1	Basic call establishment and clearing	8
10.2	Message segmentation and re-assembly	9
10.3	STATUS ENQUIRY procedure	9
10.4	Overlap sending / receiving procedures	9
10.5	Call request and transmission of the SETUP message	9
10.6	Information channel selection	9
10.7	Agreement of channel and call proceeding	10
10.8	Call confirmation indication	10

10.9	Call connected	10
10.10	Use of the PROGRESS message	10
10.11	Failure of call establishment	10
10.12	Call clearing	10
10.13	Call collisions	11
10.14	Simultaneous call attempts	11
10.15	Alternative routeing	11
10.16	Timer values	12
10.17	Support of information elements	12
10.17.1	General	12
10.17.2	Bearer capability	12
10.17.3	Call state	13
10.17.4	Called party number	14
10.17.5	Calling party number	14
10.17.6	Cause	14
10.17.7	Channel identification	15
10.18	Restart procedure for layer management	15
10.19	Generic Functional Protocol	15
10.19.1	Applicable parts of the Generic Functional Protocol	15
10.19.2	Support of information elements	16
10.19.3	Integer encoding of operation values	16
10.20	Specific supplementary services	16
10.21	Priority interruption and intrusion	17
10.21.1	Signalling procedures	17
10.21.2	Call control procedures	17
10.21.3	Invocation of priority functions at Originating PINX	18
10.21.4	Execution of SS-CPI	19
10.22	Transit counter	19
11	Call Control (CC) functions - Transit PINX case	19
11.1	General	19
Annex A	Requirements List (RL)	21
Annex B	Profile specific ICS proforma	37
Annex C	Specification and Description Language (SDL) representation of procedures for detecting and resolving Simultaneous Call Attempts	43
Annex D	Facility information element contents encoding	51

1 Scope

This Profile Standard specifies the combination of base standards, together with the selection of appropriate options and parameter values, necessary to specify how QSIG / PSS1 can be used to provide digital signalling capabilities between Private Integrated services Networks eXchange (PINX) in an Air Traffic Services (ATS) PISN.

This Standard defines:

- physical and electrical characteristics (physical layer) of the interfaces to the transmission systems to be employed;
- data link layer procedures to ensure error-free communications links;
- network layer procedures for call establishment and clearing; and
- supplementary services to meet specific ATS requirements.

This Standard states requirements upon implementations in order to achieve interoperability between equipment in ATS PISNs.

NOTE 1

Implementation of this Standard does not preclude a manufacturer from offering other means of interconnection.

This Standard does not specify requirements related to interworking between QSIG and other signalling systems used in ATS PISNs.

2 Conformance

A system conforms to this Standard if it correctly performs all the mandatory capabilities defined in the Requirement List (RL) (annex A) and the profile specific Implementation Conformance Statement (ICS) (annex B). Note that more capabilities may be mandatory than in the base standards.

3 References (normative)

The following standards contain provisions which, through reference in this text, constitute provisions of this Standard. All standards are subject to revision, and parties to agreements based on this Standard are encouraged to investigate the possibility of applying the most recent editions of the standards indicated below.

In the case of references to ECMA Standards that are aligned with ISO/IEC International Standards, the number of the appropriate ISO/IEC International Standard is given in brackets after the ECMA reference.

ECMA-133	Private Integrated Services Network (PISN) - Reference Configuration for PISN Exchanges (PINX) (International Standard ISO/IEC 11579-1)
ECMA-143	Private Integrated Services Network (PISN) - Circuit Mode Bearer Services - Inter-Exchange Signalling Procedures and Protocol (International Standard ISO/IEC 11572)
ECMA-165	Private Integrated Services Network (PISN) - Generic Functional Protocol for the Support of Supplementary Services - Inter-Exchange Signalling Procedures and Protocol (International Standard ISO/IEC 11582)
ECMA-203	Private Integrated Services Network (PISN) - Inter-Exchange Signalling Protocol - Call Intrusion Supplementary Service (International Standard ISO/IEC 14846)
ECMA-225	Private Integrated Services Network (PISN) - Inter-Exchange Signalling Protocol - Transit Counter Additional Network Feature (International Standard ISO/IEC 15056)
ECMA-253	Private Integrated Services Network (PISN) - Mapping Functions for the Employment of 64 kbit/s Circuit Mode Connections with 16 kbit/s Sub-Multiplexing (International Standard ISO/IEC DIS 17310)

ECMA-264	Private Integrated Services Network (PISN) - Inter-Exchange Signalling Protocol - Call Priority Interruption and Call Priority Interruption Protection Supplementary Services (International Standard ISO/IEC 15992)
ETS 300 290	Business TeleCommunications (BTC); 64 kbit/s digital unrestricted leased line with octet integrity (D64U); Terminal equipment interface (1994)
ETS 300 290 Amd. 1	Business TeleCommunications (BTC); 64 kbit/s digital unrestricted leased line with octet integrity (D64U); Terminal equipment interface (1995)
ETS 300 402-1	Integrated Services Digital Network (ISDN); Digital Subscriber Signalling System No. one (DSS1) protocol; Data link layer; Part 1: General aspects [ITU-T Recommendation Q.920 (1993), modified] (1995)
ETS 300 402-2	Integrated Services Digital Network (ISDN); Digital Subscriber Signalling System No. one (DSS1) protocol; Data link layer; Part 2: General protocol specification [ITU-T Recommendation Q.921 (1993), modified] (1995)
ETS 300 402-4	Integrated Services Digital Network (ISDN); Digital Subscriber Signalling System No. one (DSS1) protocol; Data link layer; Part 4: Protocol Implementation Conformance Statement (PICS) proforma specification for the general protocol (1999)
ISO/IEC 9646-7	Information technology - Open Systems Interconnection - Conformance testing methodology and framework - Part 7: Implementation Conformance Statements (1994)
ITU-T Rec. G.728	Coding of speech at 16 kbit/s using low-delay code excited linear prediction (1992)
ITU-T Rec. I.112	Vocabulary of terms for ISDNs services (1993)
ITU-T Rec. I.130	Method for the characterization of telecommunication services supported by an ISDN and network capabilities of an ISDN (Blue Book) (1988)
ITU-T Rec. I.140	Attribute technique for the characterization of telecommunication services supported by an ISDN and network capabilities of an ISDN (1993)
ITU-T Rec. I.210	Principles of telecommunication services supported by an ISDN and the means to describe them (1993)
ITU-T Rec. T.50	International Reference alphabet (IRA) (Formerly International Alphabet No. 5 or IA5) - Information technology - 7-bit coded character set for information interchange (1992)

4 Definitions

For the purposes of this Standard, the following definitions apply.

4.1 External definitions

This Standard uses the following terms defined in other documents:

- C reference point	(ECMA-133)
- Destination PINX	(ECMA-165)
- End PINX	(ECMA-165)
- Gateway PINX	(ECMA-143)
- Incoming Call	(ECMA-143)
- Inter-PINX Connection	(ECMA-253)
- Inter-PINX Link	(ECMA-253)
- Mapping functional group	(ECMA-133)
- Originating PINX	(ECMA-143)

- Outgoing Call (ECMA-143)
- Preceding PINX (ECMA-165)
- Private Integrated Services Network (PISN) (ECMA-133)
- Private Integrated Services Network Exchange (PINX) (ECMA-133)
- Q reference point (ECMA-133)
- Side, Incoming Side and Outgoing Side (ECMA-143)
- Source PINX (ECMA-165)
- S reference point (ECMA-133)
- Subsequent PINX (ECMA-165)
- Terminating PINX (ECMA-143)
- Transit PINX (ECMA-143)

5 List of acronyms

ACSE	Association Control Service Element
AIS	Alarm Indication Signal
ANF	Additional Network Feature
APDU	Application Protocol Data Unit
ASN.1	Abstract Syntax Notation One
ATS	Air Traffic Services
CC	Call Control
CICL	Call Intrusion Capability Level
CIPL	Call Intrusion Protection Level
CPICL	Call Priority Interruption Capability Level
CPIPL	Call Priority Interruption Protection Level
DSE	Dialogue Service Element
ETS	European Telecommunication Standard
GFT	Generic Functional Transport
HLC	High Layer Compatibility
i	Irrelevant
ICS	Implementation Conformance Statement
IPCC	Inter-PINX Connection Control
LD-CELP	Low Delay Code Excited Linear Prediction
LLC	Low Layer Compatibility
m	Mandatory
MP	MaPping
n/a	Not Applicable
NFE	Network Facilities Extension
o	Optional
o.i	Optional, qualified

PINX	Private Integrated Services Network Exchange
PISN	Private Integrated Services Network
PSS1	Private Signalling System no. 1
PTS	Private Termination System
QSIG	Q reference point SIGnalling system
RL	Requirements List
ROSE	Remote Operations Service Element
SCA	Simultaneous Call Attempt
SCM	Signalling Carriage Mechanism
SS-CI	Call Intrusion Supplementary Service
SS-CPI	Call Priority Interruption Supplementary Service
SS-CPIP	Call Priority Interruption Protection Supplementary Service
SW	SWitching
TE	Terminal Equipment
TEI	Terminal Endpoint Identifier
x	eXcluded

6 Specification framework

6.1 General

The approach taken in this Standard is to define the detailed digital signalling functions within the framework of functional groupings defined in the reference configuration for PISN eXchanges (ECMA-133). This approach abstracts the specification of the functions from any realisation as a real piece of equipment. At the same time it provides a complete model of a hypothetical system that can easily be translated to a physical implementation.

NOTE 2

The use of such a framework for describing the required functions need not constrain solutions for providing the functions nor is it intended to imply any particular design architecture. It simply provides a convenient method of specifying the required functions and, later on, the tests to confirm that such functions are supported by a particular piece of equipment.

The major PINX functions and their relationships are illustrated in figure 1; the functions are described in the following paragraphs.

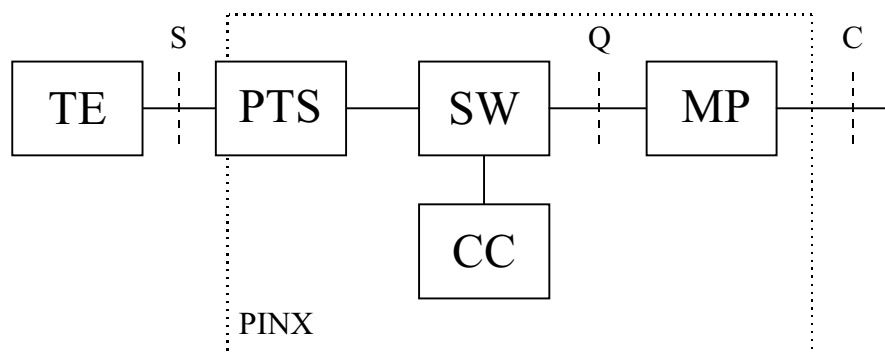

Figure 1 - Major PINX functions

The model in figure 1, and the functionality defined by it, represents a single instance of a service invocation (i.e., a call). A PINX claiming conformance with this Standard shall be capable of providing multiple simultaneous instances of the defined functions.

6.2 Terminal Equipment (TE)

The TE function provides the necessary means for a human user, by actions at the Human Machine Interface, to initiate outgoing calls to or respond to incoming calls from another TE function. The TE function may be simple (e.g., a simple telephone handset) or complex (e.g., an ATS Controller Working Position).

The detailed requirements of this function are outside the scope of this Standard.

6.3 Private Termination System (PTS)

The PTS function provides transmission and signalling capabilities between the TE function and the SW function. The PTS function, if necessary, adapts the physical, electrical and procedural conditions of the interface used to attach a TE to the PINX, to the internal conditions of the PINX.

The detailed requirements of this function are outside the scope of this Standard.

6.4 Switching (SW)

The SW function provides the capability to switch user information and signalling information.

User information is switched between the PTS function and the MP function. Selection of the switching path depends upon the parameters of the service request.

Signalling information is switched between:

- the PTS function and the CC function; and
- between the CC function and the MP function.

NOTE 3

The switching function may also switch both user and signalling information between the described functions and other functions outside the scope of this Standard.

The detailed requirements of this function are specified in clause 8.

6.5 Mapping (MP)

The MP function provides adaptation of the internal conditions of the PINX to the physical, electrical, and procedural conditions of the interface used to attach the PINX to an external transmission facility (e.g., a leased circuit) for inter-PINX communications.

The MP function also provides the multiplexing functions required to separate or merge the user information and signalling information from the PINX to the transmission facility employed.

The detailed requirements of this function are specified in clause 9.

6.6 Call Control (CC)

The CC function provides the functions necessary to control calls between TE functions attached to the ATS PISN. It incorporates all the components of the PSS1 (QSIG) protocol model (i.e., Protocol Control, Call Control, GFT-Control, the Coordination function, and applicable SS-Control entities) described in ECMA-143 and ECMA-165.

NOTE 4

The CC function also provides the functions necessary to control calls between TE functions attached to the ATS PISN and other subscribers (e.g., connected to the public telecommunications network). It can also provide signalling interworking functions when necessary. However, these aspects are outside the scope of this Standard.

NOTE 5

In this Standard, requirements applicable to the CC function are specified separately for each of the following cases:

- *Outgoing and Incoming sides of a ATS QSIG Call (End PINX case); and,*

- *Interworking between an Incoming side and an Outgoing side (Transit PINX case).*

The detailed requirements of this function are specified in clauses 10 and 11.

7 Physical interface and protocol stack at the C reference point

Figure 1 above also shows, using vertical dashed lines, the "reference points" at which physical interfaces may occur. This Standard defines the required behaviour at a physical interface at the C reference point. Figure 2 below shows the protocol stack applicable at the C reference point.

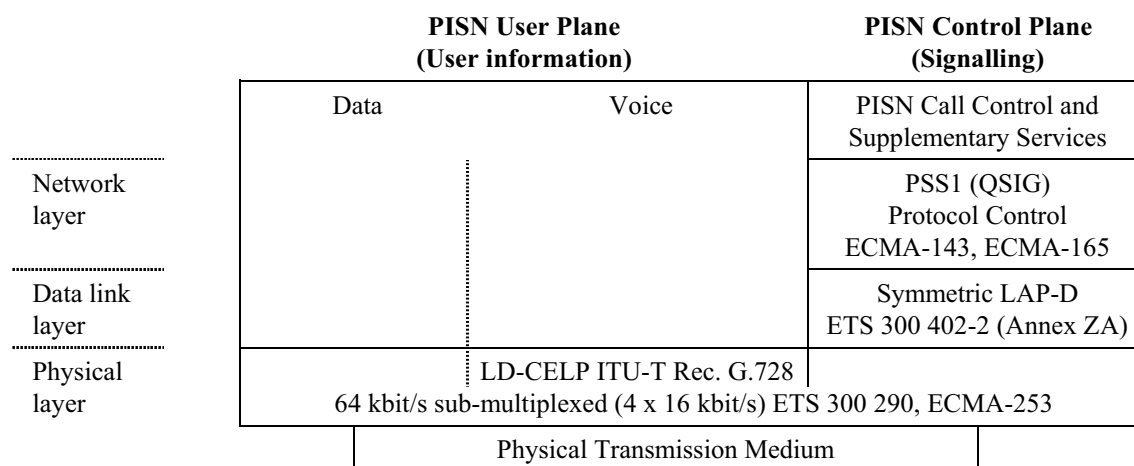

Figure 2 - Protocol stack

8 Switching (SW) functions

8.1 Speech compression

For 16 kbit/s speech calls in which the PINX acts as the "End PINX", the SW function shall provide a speech compression and decompression capability (CELP codec) according to the requirements of ITU-T Recommendation G.728. Outgoing speech information from the PINX shall be compressed using the encoding algorithm specified in ITU-T Recommendation G.728. Speech information incoming to the PINX shall be decompressed using the decoding algorithm specified in ITU-T Recommendation G.728.

NOTE 6

The CELP codec described in ITU-T Recommendation G.728 contains selectable options to permit operation with modem or other non-speech signals. Such operation is not anticipated in the ATS context.

The bit-stealing method, as specified in ITU-T Recommendation G.728 / § 3.11, shall be used for synchronising the LD-CELP bitstream. The stolen bits shall be an alternating sequence of zeros and ones (i.e., either 010101... or 101010...).

For calls in which the PINX acts as a "Transit PINX", speech information shall not be decompressed and re-compressed.

9 Mapping (MP) functions

9.1 Physical layer functions

NOTE 7

The physical interface and sub-multiplexing techniques specified in 9.1.1 below have been selected as appropriate for ATS PISNs. The inclusion of other physical interfaces (e.g., at 2 048 kbit/s) in a future edition of this Standard is not precluded.

One consequence of this is that the number of channels and their attributes (e.g., information transfer rate, user information layer 1 protocol) at the Q reference point may be different from that presently specified.

Such a change implies changes to the requirements to be met by the Mapping function and the Call Control function.

A further consequence is that, when the inter-PINX connection is provided by means of a leased circuit, establishment of the connection is achieved through an administrative procedure with the leased circuit provider. Functions for the control of the connection (i.e., the IPCC functional group, as specified in ECMA-133) are needed only when on-demand connections (e.g., through the public ISDN) are used as the inter-PINX connection.

Suppliers should be aware of these possibilities and may wish to design their solutions accordingly.

9.1.1 Physical and electrical interface requirements

The MP function shall meet the requirements for physical and electrical characteristics specified in ETS 300 290 and its amendment.

9.1.2 Rate adaptation and sub-multiplexing

The MP function shall meet the requirements specified in ECMA-253 for sub-multiplexing a 64 kbit/s circuit-mode inter-PINX connection into 4 x 16 kbit/s channels.

The MP function shall provide a rate adaptation capability. Incoming speech information shall be adapted to the internal channel rate. Outgoing speech information shall be adapted from the internal channel rate to the rate required by the external transmission facility, as specified in ECMA-253.

9.1.3 Alarm Indication Signal (AIS)

If the MP function receives multiple octets (i.e., >3 octets) containing an all one's bit pattern from the external transmission facility it shall assume this to be an Alarm Indication Signal (AIS). The MP function shall assume the transmission facility and / or the peer PINX is out of service and take appropriate management action.

The MP function shall be capable of sending AIS towards the external transmission facility when it detects loss of bit violations in the received bit stream. On resumption of normal bit violations the MP function shall stop sending AIS.

NOTE 8

There may be other, implementation dependant, circumstances when the MP function is required to send AIS. These are outside the scope of this Standard.

9.1.4 Synchronisation

Synchronisation functions of the MP function shall be compatible with the synchronisation strategy of the PINX. That is to say, the MP function shall be capable of both (but not simultaneously):

- Extracting the timing received at the receive side of the physical interface and delivering it as an external clock source for the entire system, and synchronising the MP function's own output timing to this source; and
- Synchronising the MP function's own output timing to another clock source not derived from the physical interface associated with this MP function.

Selection of the option shall be by system configuration and runtime determination.

9.2 Data link layer functions

9.2.1 General procedures

The MP function shall support data link layer procedures as specified in annex ZA of ETS 300 402-2, with modifications as specified in the following subclauses.

NOTE 9

In these subclauses, references of the form: (§ x.x.x) refer to subclauses in ETS 300 402-2. References of the form (see x.x.x) refer to the present document.

A PINX shall provide a management means of configuring the MP function for each inter-PINX link to be either the "master" side or the "slave" side (§ ZA.2.3.2). The designation of any particular MP function as either a "master" or a "slave" shall not be influenced by nor shall it influence the configuration of any other MP function in the same PINX.

There is no need for a PINX to support the unacknowledged mode of operation (§ ZA.4.2).

When no layer 3 information is to be transmitted, the transmitting data link layer entity shall continuously send flag sequences in the D-channel (§ ZA.1.2).

NOTE 10

This requirement permits the receiving data link entity to perform octet synchronisation functions (9.3 below) without impact on the transmitting entity.

The transmitting data link layer entity shall always send an opening flag and a closing flag for each layer 2 frame transmitted (i.e., the closing flag of one frame shall not serve as the opening flag of the next frame) (§ ZA.1.2).

NOTE 11

This requirement permits the receiving data link entity to perform octet synchronisation functions without impact on the transmitting entity.

9.2.2 System parameters

The default values shall apply for all system parameters (§ ZA.4.9), as specified in table 1 below. A PINX should provide a means for configuring parameters individually for each inter-PINX link.

Table 1 - Layer 2 parameter values

Parameter	Description	Value	Default value?
K	Maximum number of outstanding I-frames	3	Yes
T200	Frame transmission timer (minimum time between frames)	1 s	Yes
T201	Minimum time between re-transmission of TEI identity check messages	Not used	Not used
T202	Minimum time between re-transmission of TEI identity request messages	Not used	Not used
T203	Maximum time between frames	10 s	Yes
N200	Maximum number of re-transmissions	3	Yes
N201	Maximum number of octets in an information field	260	Yes
N202	Maximum number of transmissions of TEI identity check messages	Not used	Not used

9.3 Octet synchronisation procedure

The MP function shall provide an octet synchronisation procedure to permit recovery from slips in the 64 kbit/s bitstream.

NOTE 12

Such a procedure is required for an interim period during which some 64 kbit/s leased circuits may be unable to guarantee octet integrity.

It shall be possible to enable and disable the procedure on any inter-PINX link by means of management actions.

When the octet synchronisation procedure is enabled for a particular inter-PINX link, the MP function shall continuously monitor the link and correct for loss of octet synchronisation.

10 Call Control (CC) functions - End PINX case

10.1 Basic call establishment and clearing

The requirements of ECMA-143 shall apply, with modifications as specified in the following subclauses.

NOTE 13

Subclauses 10.2 - 10.4 specify aspects of QSIG that do not need to be supported by a PINX. Subclauses

10.5 and onwards specify requirements additional to those in ECMA-143. The headings used in subclauses 10.5 onwards correspond to heading titles in ECMA-143.

NOTE 14

In these subclauses, references of the form: (§ x.x.x) refer to subclauses in ECMA-143. References of the form (see x.x.x) refer to the present document.

10.2 Message segmentation and re-assembly

Annex ZA (Message segmentation and re-assembly) of ECMA-143 shall not apply.

10.3 STATUS ENQUIRY procedure

A PINX shall not support initiation of the STATUS ENQUIRY procedure (§ 9.3.1).

NOTE 15

This means that the options in various error cases (e.g., where a message is received with a message type or message sequence error (§ 9.2.4), or during data link reset (§ 9.2.8) or failure (§ 9.2.9)) of ECMA-143 that permit an entity to send a STATUS ENQUIRY message shall not be supported.

10.4 Overlap sending / receiving procedures

A PINX (Incoming Side) need not support the Overlap Receiving state (§ 7.1.14). Similarly a PINX acting as a Transit PINX need not support the TCC_Await Additional Digits state (§ 10.4.3).

A PINX (Outgoing Side) shall not initiate calls using states and procedures for overlap sending.

10.5 Call request and transmission of the SETUP message

Call request (§ 10.1.1) and transmission of the SETUP message (§ 10.5.1) shall be modified according to the requirements in the following paragraphs.

If, due to congestion, no B-channel is available for the requested call, and if previously requested (e.g., by the TE function due to Class of Service or Priority Key depression), Call Control shall immediately perform the "execution" function of the Call priority interruption supplementary service (see 10.21.4). If no request for call priority interruption was made, Call Control shall initiate call establishment on an alternative route (see 10.15).

If, due to a reason other than congestion, no B-channel is available, Call Control shall initiate call establishment on an alternative route (see 10.15).

The Bearer capability information element sent in the SETUP message shall be encoded (see 10.17.2) to indicate "Speech 16 kbit/s" or "Unrestricted digital information 16 kbit/s", as appropriate.

The Called party number information sent in the SETUP message shall be complete. The transmitted SETUP message shall always contain the Sending complete information element.

Within the Calling party number and Called party number information elements, the Type of number field shall always be encoded as "PISN specific number". The Numbering plan identification field shall always be encoded as "Private numbering plan".

The Channel identification information element shall be encoded using "channel numbering". The "channel map" coding option shall not be used.

The transmitted SETUP message shall always contain the Transit counter information element, as specified in ECMA-225, with the transit count field set to the value zero.

If requested (e.g., by the TE function due to Class of Service or Priority Key depression), the transmitted SETUP message shall contain a Facility information element containing the callInterruptionRequest invoke APDU of the Call priority interruption supplementary service (see 10.21).

On the first expiry of timer T303 the Outgoing Side shall send a RELEASE COMPLETE message to the Incoming Side containing cause number 102 "recovery on timer expiry". The PINX shall initiate call establishment on an alternative route (see 10.15).

10.6 Information channel selection

A PINX shall provide a management means of configuring the CC function for each inter-PINX link to be either the "A" side or the "B" side. The designation of any particular CC function as either an "A" side or a

"B" side shall not be influenced by nor shall it influence the configuration of any other CC function in the same PINX.

When initiating a call a PINX shall assign channels starting with the lowest available channel number if it is the "A" side and the highest available channel number if it is the "B" side (§ 10.3).

Call Control (Outgoing Side) shall indicate the selected channel as "preferred" in the Channel identification information element (§ 10.1.2).

If no channel is available when the SETUP message is received by the Incoming Side (assuming that the Outgoing Side sent the SETUP message when a channel was available), the Incoming Side shall check to determine whether call collision has occurred. If a call collision has occurred the PINX shall proceed as described in 10.13. If no call collision has occurred, the Incoming Side shall send a RELEASE COMPLETE message containing cause number 34 "no circuit/channel available".

10.7 Agreement of channel and call proceeding

On receipt of the first message (normally CALL PROCEEDING) in response to the transmitted SETUP message indicating the channel to be used, the Outgoing Side shall through-connect the channel in both directions of transmission. If the Incoming Side indicated an alternative channel, the Outgoing Side shall use this channel (§ 10.1.2); the Outgoing side shall not clear the call in this case.

On receipt of a CALL PROCEEDING message an Outgoing Side shall always start timer T310. The value of timer T310 is specified in 10.16.

On expiry of timer T310 (occurs first in the Originating PINX) the Outgoing Side shall initiate call clearing. The clearing cause sent to the Incoming Side shall be cause number 102 "recovery on timer expiry". The PINX shall initiate call establishment on an alternative route (see 10.15).

10.8 Call confirmation indication

The Outgoing Side shall start Timer T301 on receipt of an ALERTING message. The value of timer T301 is specified in 10.16.

On expiry of timer T301 the Outgoing Side shall initiate call clearing. The clearing cause sent to the Incoming Side shall be cause number 19 "no answer from user (user alerted)".

10.9 Call connected

A PINX (Incoming Side) shall not support the Connect Request state (§ 7.1.8), timer T313, and the associated procedures (§ 10.1.6).

On receiving an indication that the call has been answered and requires through-connection of the B-channel in both directions of transmission, the Incoming Side shall send a CONNECT message to the Outgoing Side and enter the Active state (§ 10.1.6).

On receipt of the CONNECT message the Outgoing Side shall stop timers T310 and/or T301 and enter the Active state (§ 10.1.6). A CONNECT ACKNOWLEDGE message shall not be sent.

10.10 Use of the PROGRESS message

NOTE 16

During call establishment, the call may leave the ATS QSIG environment due to interworking with another signalling system. The PINX at the point of interworking (the Outgoing Gateway PINX) will send progress indications to indicate this.

On receipt of a PROGRESS message containing a Progress indicator information element containing progress description number 1 "call is not end-to-end ISDN, further call progress information may be available in-band" timer T310 shall be stopped. (§ 10.1.7)

10.11 Failure of call establishment

No additional requirements (§ 10.1.8).

10.12 Call clearing

In the exception case where call clearing is initiated towards the called user before a channel has been agreed (§ 10.2.2, 3rd item) the RELEASE message shall be used. A DISCONNECT message shall not be used in this case.

10.13 Call collisions

NOTE 17

Call collision occurs when two calls originating from PINX at opposite ends of an inter-PINX link attempt to use the same B-channel. ECMA-143 specifies how this situation shall be dealt with.

The procedures specified in the first case ("A" side preferred, "B" side preferred) of § 10.3 of ECMA-143 shall apply, except:

- When the priorities of the colliding calls are different; or,
- When the colliding calls are calls involved in a simultaneous call attempt (see 10.14) and the procedure described in annex C is supported.

NOTE 18

In the first case above, Call Priority Interruption Capability Level (CPICL) information (see 10.21.3) can be used to determine the priority of each call.

NOTE 19

In the second case above, the procedure described in annex C resolves call collision occurring between the calls involved in a simultaneous call attempt (see 10.14).

If no free channel exists the call originating from the "B" side shall be cleared. The "B" side shall attempt to establish the call using an alternative route (10.15).

In the case where the relative priorities of the colliding calls are different, the call with the higher priority shall be awarded the channel. An alternative channel (if free channels exist) shall be indicated in the first response to the side originating the lower priority call (§ 10.3). If no free channel exists the lower priority call shall be cleared. The side originating the lower priority call shall attempt to establish the call using an alternative route (10.15).

10.14 Simultaneous call attempts

NOTE 20

A simultaneous call attempt exists when user A attempts to call user B at the same time as user B attempts to call user A. Calls representing such attempts may be made from opposite ends of the same route between the two destinations, or they may take separate routes through the network. The two calls involved in a simultaneous call attempt may be of equal or unequal priority. Occasionally, the two calls may also be involved in a call collision.

Successful detection and resolution of all simultaneous call attempt cases is dependent on both network topology and the capabilities and design of the equipment (PINXs and Terminal Equipment) involved. Thus, this Standard cannot specify the procedures necessary to cover all cases completely. Readers are advised to be aware of this.

When resolving simultaneous call attempts the objective should be to successfully establish communication between the users. Users should not receive an indication of "busy" nor should they be left in an indeterminate call state. However, the precise procedures are implementation dependent.

Annex C describes a procedure that can be used for detecting and resolving simultaneous call attempts occurring in the single Inter-PINX Link scenario (i.e., two End PINXs interconnected via a single Inter-PINX Link).

10.15 Alternative routing

For each possible destination address, a PINX shall maintain an ordered list of up to 5 alternative routes. Each list shall be configurable by management means.

The routing algorithm to be used under normal conditions, for routing calls with no priority, shall be based on attempting to establish the call on each route in a list sequentially, with the most direct route being the first attempted. A PINX shall await the outcome of the call attempt on a particular route before proceeding to try the next available route.

NOTE 21

High priority calls take a different approach based on pre-empting busy circuits (see 10.21 and 10.5).

10.16 Timer values

The values to be used for timers specified in ECMA-143 shall be those indicated in table 2 below.

Table 2 - Timer values

Timer	Purpose	Required value
T301	ALERTING received	120 s
T302	Sending of SETUP ACK	Not used
T303	On sending SETUP	4 s
Second T303	On retransmission of SETUP	Not used
T304	Receipt of SETUP ACK	Not used
T305	On sending DISCONNECT	4 s
T308	On sending RELEASE	4 s
Second T308	On retransmission of RELEASE	4 s
T309	SCM disconnection	90 s
T310	On receipt of CALL PROCEEDING	110 s
T313	On sending CONNECT	Not used
T314	Segmentation timer	Not used
T316	On sending of RESTART	120 s
T322	STATUS ENQUIRY sent	Not used

It shall be possible to alter timer values by configuration means.

10.17 Support of information elements

10.17.1 General

NOTE 22

The requirements for the support and encoding of information elements (§ 14) specified in this and subsequent subclauses are additional to any implied requirements arising from the procedures specified for Basic Call establishment and clearing in preceding subclauses.

A Call Control function need not generate the following information elements:

- Called party subaddress;
- Calling party subaddress;
- Connected number;
- Connected party subaddress;
- High layer compatibility (HLC); and,
- Low layer compatibility (LLC).

An End PINX receiving a message containing one or more of the non-mandatory information elements listed above shall ignore those information elements that it does not recognise (§ 10.6.1).

NOTE 23

A Transit PINX must transparently pass-on these information elements (§ 10.4.11.2).

Other information elements shall be supported as described in ECMA-143 (§ 14), with modifications as specified in the following subclauses.

10.17.2 Bearer capability

NOTE 24

Codepoints indicated in this subclause are specified in ECMA-253 (ISO/IEC 17310).

NOTE 25

The future use of other codepoints in conjunction with a different physical interface (e.g., 2 048 kbit/s) is not precluded.

For "Speech 16 kbit/s" calls the fields of the Bearer capability information element shall be encoded as shown in figure 3 below.

8	7	6	5	4	3	2	1	
Bearer capability								
0	0	0	0	0	1	0	0	Octet 1
Information element identifier								
Length of Bearer capability contents (3)								Octet 2
1	0	1	0	0	0	0	0	Octet 3
ISO/IEC std.		Speech						
1	0	0	1	0	0	1	0	Octet 4
Circuit-mode		16 kbit/s						
1	0	1	0	1	0	1	0	Octet 5
Layer 1		G.728 LD-CELP						

Figure 3 - Bearer capability - "Speech 16 kbit/s"

For "Unrestricted digital information 16 kbit/s" calls the fields of the Bearer capability information element shall be encoded as shown in figure 4 below.

8	7	6	5	4	3	2	1	
Bearer capability								
0	0	0	0	0	1	0	0	Octet 1
Information element identifier								
Length of Bearer capability contents (2)								Octet 2
1	0	1	0	1	0	0	0	Octet 3
ISO/IEC std.		Unrestricted digital information						
1	0	0	1	0	0	1	0	Octet 4
Circuit-mode		16 kbit/s						

Figure 4 - Bearer capability - "Unrestricted digital information 16 kbit/s"

10.17.3 Call state

With the exception of values 2 (overlap sending) and 8 (connect request), any of the call state values or global call reference state values specified in table 25 of ECMA-143 may be encoded in the call state value field (octet 3) of the Call state information element.

10.17.4 Called party number

The fields of the Called party number information element shall be encoded as shown in figure 5 below.

8	7	6	5	4	3	2	1	
Called party number								
0	1	1	1	0	0	0	0	Octet 1
Information element identifier								
Length of Called party number contents (7) (NOTE 26)								Octet 2
1	0	1	1	1	0	0	1	Octet 3
PISN specific number				Private numbering plan				
0	1st number digit (encoded according to ITU-T Rec. T.50)							Octet 4a
0	2nd number digit (encoded according to ITU-T Rec. T.50)							Octet 4b
0	3rd number digit (encoded according to ITU-T Rec. T.50)							Octet 4c
0	4th number digit (encoded according to ITU-T Rec. T.50)							Octet 4d
0	5th number digit (encoded according to ITU-T Rec. T.50)							Octet 4e
0	6th number digit (encoded according to ITU-T Rec. T.50)							Octet 4f

Figure 5 - Coding of Called party number information element

NOTE 26

Although ATS PISNs currently use a 6 digit numbering plan, the use of more digits in the future is not precluded.

10.17.5 Calling party number

The fields of the Calling party number information element shall be encoded as shown in figure 6 below.

8	7	6	5	4	3	2	1	
Calling party number								
0	1	1	0	1	1	0	0	Octet 1
Information element identifier								
Length of Calling party number contents (7) (NOTE 27)								Octet 2
1	0	1	1	1	0	0	1	Octet 3
PISN specific number				Private numbering plan				NOTE 28
0	1st number digit (encoded according to ITU-T Rec. T.50)							Octet 4a
0	2nd number digit (encoded according to ITU-T Rec. T.50)							Octet 4b
0	3rd number digit (encoded according to ITU-T Rec. T.50)							Octet 4c
0	4th number digit (encoded according to ITU-T Rec. T.50)							Octet 4d
0	5th number digit (encoded according to ITU-T Rec. T.50)							Octet 4e
0	6th number digit (encoded according to ITU-T Rec. T.50)							Octet 4f

Figure 6 - Coding of Calling party number information element

NOTE 27

Although ATS PISNs currently use a 6 digit numbering plan, the use of more digits in the future is not precluded.

NOTE 28

A Call Control function need not generate octet 3a (presentation / screening indicator), but should be prepared to receive a Calling party information element containing octet 3a, without treating it as an error.

10.17.6 Cause

A Call Control function need not generate octet 5 (Diagnostics), but should be prepared to receive a Cause information element containing octet 5, without treating it as an error.

The Location field (octet 3, bits 4-1) shall be encoded as "0 0 0 1" (Private network serving the local user), unless interworking with another network is involved.

10.17.7 Channel identification

The Channel number (octet 3.3) shall be encoded as the binary number (range 1-3) assigned to the channel, as specified in 8.2.1 of ECMA-253.

NOTE 29

The range of channel numbers permitted is appropriate to support one inter-PINX connection according to the requirements of ECMA-253. The future specification of other inter-PINX connections with different physical interfaces, and hence different ranges of channel numbers, is not precluded.

10.18 Restart procedure for layer management

The restart procedure (§ 11.1) shall not be used to restart single channels. Hence, only the value "1 1 1" (All channels) shall be used in the Restart indicator information element.

In the case that timer T308 expires for the second time, the appropriate channel in the link shall be placed in an "out-of-service" condition. Call Control shall inform the appropriate management and maintenance entity. Under automatic or manual control the management and maintenance entity may invoke the restart procedure for the complete link.

NOTE 30

Other circumstances in which the restart procedure can be used are system dependant, and outside the scope of this Standard.

10.19 Generic Functional Protocol

10.19.1 Applicable parts of the Generic Functional Protocol

To permit support of QSIG supplementary services, a PINX shall support a subset of the Generic Functional Protocol specified in ECMA-165.

A PINX shall support the Remote Operations Service Element (ROSE) and the connection oriented APDU transport mechanism. Requirements for other service elements (i.e., ACSE and DSE) and for other transport mechanisms (i.e., connection-less APDU transport) need not be supported. Table 3 below identifies the applicable subclauses of ECMA-165 specifying the necessary requirements.

Table 3 - Applicable and non-applicable clauses of ECMA-165

Applicable subclauses of ECMA-165	Non-applicable subclauses of ECMA-165
1, 2, 3, 4, 5, 6.1(a), 6.2, 6.3, 6.4, 6.7.1, 6.7.3, 6.8.1, 6.8.3, 6.9, 7.1, 7.3 (NOTE 31), 7.4, 8.1.1, 8.1.2, 8.2, 10, 11	6.1(b), 6.1(c), 6.5, 6.6, 6.7.2, 6.8.2, 7.2, 8.3, 8.4, 9 (NOTE 32)

NOTE 31

Support of the call independent signalling mechanism (7.3 in ECMA-165) is not specifically required for ATS PISNs at present. However, future editions of this Standard may introduce additional supplementary services for which it is needed. Suppliers are advised to take account of this in their implementations.

NOTE 32

Suppliers may choose whether or not to support manufacturer specific operations.

The procedures for call independent signalling connections (7.3 in ECMA-165) contain several options. In these cases the appropriate modifications specified in this Standard as applicable for Basic Call shall also apply to call independent signalling connections.

10.19.2 Support of information elements

The fields of the Facility information element shall, in accordance with 11.3.3 of ECMA-165, be encoded as shown in figure 7 below.

8	7	6	5	4	3	2	1	
Facility								
0	0	0	1	1	1	0	0	Octet 1
Information element identifier								
Length of information element contents								Octet 2
1	0	0	1	1	1	1	1	Octet 3
Networking extensions								
Network Facility Extension (NFE) (NOTE 33)								Octet 3.1
Service APDU(s) (NOTE 33)								Octets 4 etc.

Figure 7 - Facility information element

NOTE 33

The content of the Network Facility Extension (NFE) and the Service APDU octets depends upon the specific supplementary service information conveyed. This can be determined by reference to the descriptions of individual supplementary services.

The fields of the Notification indicator information element shall, in accordance with 11.3.4 of ECMA-165, be encoded as shown in figure 8 below.

8	7	6	5	4	3	2	1	
Notification indicator								
0	0	1	0	0	1	1	1	Octet 1
Information element identifier								
Length of information element contents								Octet 2
1	1	0	0	0	0	0	0	Octet 3
Discriminator for notification extension								
ASN.1 encoded Notification Data Structure (NOTE 34)								Octet 3.1

Figure 8 - Notification indicator information element

NOTE 34

The content of the ASN.1 encoded Notification Data Structure octets depends upon the specific notification information conveyed. This can be determined by reference to the descriptions of individual supplementary services.

10.19.3 Integer encoding of operation values

The contents of an information element field defined using ASN.1 notation shall be encoded using the integer encoding scheme for standardised Notification, Operation and Error values i.e., the object identifier scheme shall not be used.

NOTE 35

Annex D illustrates the contents of the Facility information element, encoded according to the foregoing rules, when conveying the various operations, errors and notifications of the supplementary services used in the application of PSS1 (QSIG) to ATS PISNs.

10.20 Specific supplementary services

A PINX shall support at least those supplementary services necessary for the performance of basic air traffic management functions. These are specified in the following subclauses, in the context in which they are used.

10.21 Priority interruption and intrusion

10.21.1 Signalling procedures

Signalling protocol and procedures for the Call priority interruption and Call priority interruption protection supplementary services (SS-CPI and SS-CPIP respectively) shall be supported in accordance with ECMA-264.

Signalling protocol and procedures for the Call intrusion supplementary service (SS-CI) shall be supported in accordance with ECMA-203. A PINX need only support the following options:

- Invocation without path retention; and,
- Conference type connection.

The values to be used for the SS-CI timers specified in ECMA-203 shall be those indicated in table 4 below.

Table 4 - Values for SS-CI timers

Timer	Purpose	Required value
T1	Absence of response to SS-CI invocation by Originating PINX	30 s
T2	Absence of response to a request for isolation	Not used
T3	Absence of response to a request for forced release	Not used
T4	Absence of response to a request for wait on busy	Not used
T5	Absence of response to request for CIPL value by Terminating PINX	10 s
T6	Length of impending intrusion warning	10 s
PRT1	Path retention timer (see note to item B5 in subclause A.3.4.1.2 of annex A)	60 s

10.21.2 Call control procedures

Calls with a bearer capability of "Unrestricted digital information 16 kbit/s" shall not be capable of interrupting other calls. Neither shall such calls be interruptible by other calls. Thus, they shall have CPICL / CICL = 0 and CPIPL / CIPL = 3.

For calls with a bearer capability of "Speech 16 kbit/s", Call Control shall support procedures for interruption and intrusion as specified in the following subclauses.

NOTE 36

Each TE function is assigned (e.g., by class of service) a priority level; any call made from a particular TE function assumes that priority level. Regardless of the priority assigned to the TE function, depression of a "Priority" key elevates the priority of a call to the highest priority level ("high priority"). A high priority call can interrupt a call with a lower priority to gain access to busy trunk resources or to a busy user.

NOTE 37

Call interruption and intrusion occurs as a result of:

- a) A TE function with an assigned priority initiating a call request; or,*
- b) A "Priority" key depression:*
 - Prior to a call request being initiated;*
 - After receipt of a busy (congestion) signal due to the unavailability of circuits;*
 - After receipt of a busy signal due to the called user being busy;*
 - After waiting for the called user to answer (no reply) (see NOTE 40).*

Only high priority calls routed on their "preferred" route shall be capable of interrupting other calls. The first route in a list of alternative routes (see 10.15), assumed to be the most direct route to a destination,

shall be considered to be the preferred route. In the event of the preferred route being unavailable due to a failure, a PINX shall temporarily consider the subsequent alternative route to be the preferred route for the purpose of processing priority calls.

10.21.3 Invocation of priority functions at Originating PINX

When a TE function with an assigned priority initiates a call request, Call Control shall invoke SS-CPI. Call Control shall encode the Call Priority Interruption Protection Level (CPIPL) as shown in table 5 below, and send the information with the SETUP message transmitted to the next PINX (see 10.5). No Call Priority Interruption Capability Level (CPICL) information shall be included in the SETUP message i.e., the call is established as a protected call only.

Table 5 - Encoding of protection levels (assigned priority cases)

Source of invocation	Protection level
From "medium priority" TE function	2
From "low priority" TE function	1
From TE function with no assigned priority (also, the value to be assumed for calls without protection information)	0

When a "Priority" key is depressed, and there is no call request in progress from the TE function in question, Call Control shall wait until the next call request is received from the TE function before invoking both SS-CPI and SS-CI.

NOTE 38

SS-CPI is invoked in case congestion is encountered during the call attempt. SS-CI is invoked to break through any user busy situation, should this be encountered.

Call Control shall encode the CPICL, CPIPL, and Call Intrusion Capability Level (CICL) as shown in table 6 below. The coded CPICL, CPIPL, and CICL information shall be sent with the SETUP message transmitted to the next PINX (see 10.5).

Table 6 - Encoding of capability / protection levels (Priority key cases)

Source of invocation	Capability level	Protection level
Through "Priority" key depression (high priority)	3	3

NOTE 39

The capability and protection levels for the priority key case apply for both SS-CPI and SS-CI.

When a "Priority" key is depressed, and there is a call request in progress in which the calling user is receiving a busy (congestion) indication, Call Control shall terminate the existing call request using normal call clearing procedures (§ 10.2). Call Control shall invoke both SS-CPI and SS-CI, and immediately re-initiate a call attempt towards the same destination. The CPICL, CPIPL, and CICL shall be encoded as shown in table 6 above and shall be sent with the SETUP message transmitted to the next PINX (see 10.5).

When a "Priority" key is depressed, and there is a call request in progress in which the calling user is receiving a busy indication due to the called user being busy, Call Control shall terminate the existing call request using normal call clearing procedures (§ 10.2). Call Control shall invoke both SS-CPI and SS-CI, and immediately re-initiate a call attempt towards the same destination. The CPICL, CPIPL, and CICL shall be encoded as shown in table 6 above, and shall be sent with the SETUP message transmitted to the next PINX (see 10.5).

When a "Priority" key is depressed, and there is a call offer in progress (i.e., the calling user is receiving ringback but no reply from the called user), Call Control shall terminate the existing call request using normal call clearing procedures (§ 10.2). Call Control shall invoke both SS-CPI and SS-CI and immediately re-initiate a call attempt towards the same destination. The CPICL, CPIPL, and CICL shall be encoded as shown in table 6 above, and shall be sent with the SETUP message transmitted to the next PINX (see 10.5).

NOTE 40

The effect at the Terminating PINX, of invoking SS-CI in this case, depends on the nature of the called destination and the design of the Terminating PINX. For genuinely ringing "simple telephones" where no one answers there will be no effect. For complex terminal equipment with multiple line appearances (such as an ATS Controller Working Position), the effect of the request for call intrusion should be to cause intrusion into whichever call is presently in an active or talking state.

10.21.4 Execution of SS-CPI

Execution of SS-CPI can occur at any PINX meeting congestion on the route to a subsequent PINX.

If all B-channels in the preferred route are occupied (e.g., as determined in 10.5), Call Control shall check the CPICL of the call to be established, to determine whether call priority interruption is permitted. Calls with a CPICL value of 3 can interrupt; calls with other CPICL values shall not interrupt.

If interruption is not permitted, Call Control shall attempt to establish the call using an alternative route (see 10.15).

If interruption is permitted, Call Control shall select, from the calls using channels on the preferred route, a call with a CPIPL lower than the CPICL of the call to be established. If more than one call has a CPIPL lower than the CPICL of the call to be established, then the call with the lowest CPIPL shall be selected. If several calls have the same lowest CPIPL, Call Control may select any one of these.

Having selected the call to be interrupted, Call Control shall inform the parties involved that the call is to be released. Call Control shall do this by sending a NOTIFY message containing notification value "interruptionIsImpending" to each party in the call. Call Control shall also start the "Interruption pending" timer.

NOTE 41

Usually, there will only be 2 parties involved in the call to be released. The action to be taken in the case where the call to be released involves more than 2 parties (i.e., a conference) is implementation dependant.

On expiry of the Interruption pending timer Call Control shall force release the call to be interrupted by sending a RELEASE message containing the notification value "interruptionForcedRelease" to each party involved in the call.

On receiving a notification of an impending interruption, a PINX shall inject an audible tone (Interrupt warning tone) into the voice path to the user. This tone shall be applied until the interruptionForcedRelease notification is received. On receipt of this notification the PINX shall continue to clear the call using normal call clearing procedures (§ 10.2.3).

When clearing of the interrupted call has been completed, Call Control shall continue establishment of the priority call using the newly available B-channel. Call Control shall encode the CPICL and the CPIPL as shown in table 6 above, and send the coded CPICL and CPIPL information with the SETUP message transmitted to the next PINX (see 10.5).

10.22 Transit counter

Transit counter functionality, as specified in ECMA-225, shall be supported.

A PINX shall provide a management means of configuring the acceptable (network dependent) value that the transit count field shall be allowed to reach (§ 6.4.3.2 of ECMA-225).

11 Call Control (CC) functions - Transit PINX case

11.1 General

Where appropriate, the modifications to the requirements of ECMA-143 for End PINX expressed above shall also apply to a PINX acting as a transit node (§ 10.4). In addition, the modifications to requirements specified in this clause shall also apply.

A Transit PINX shall through-connect the B-channel in both directions of transmission on receipt of the first message in response to SETUP indicating the B-channel to be used (§ 10.4.5).

A Transit PINX shall not discard any Progress message received in the TCC_Call Active state (§ 10.4.9).

A Transit PINX, on receipt of a DISCONNECT, RELEASE, or RELEASE COMPLETE message from the Subsequent PINX prior to reaching the TCC_Call Alerting state shall not attempt "other (unspecified) procedures" (§ 10.4.10.1).

A Transit PINX need not support procedures for the application of in-band tones and announcements during the call clearing phase (§ 10.4.10.2).

NOTE 42

This means a Transit PINX need not support states 11, 12, and 13 (§ 8.1) and the procedures associated with them.

Annex A

(normative)

Requirements List (RL)

A.1 General

Use of this Standard imposes requirements on the implementation that go beyond those of the base standards referred to by this Standard. These result in modifications to the requirements expressed in the PICS proformas for the base standards. This annex specifies the modifications (the Requirements List - RL) that apply to the status of the items affected in each PICS proforma, with consequently modified requirements on the answers to be provided.

The status notation used in this annex is that defined in ISO/IEC 9646-7. In summary, the meaning of the notations is as follows:

- i Irrelevant or out-of-scope - this capability is outside the scope of this profile and is not subject to conformance testing in this context.
- m Mandatory - the capability is required to be supported.
- n/a Not Applicable - in the given context, it is impossible to use the capability.
- o Optional - the capability may be supported or not.
- o.i qualified optional - for mutually exclusive or selectable options from a set. "i" is an integer that identifies an unique group of related optional items and the logic of their selection, defined below the table.
- x eXcluded or prohibited - there is a requirement not to support this capability in this profile.

The Requirements List in this annex shall be used to restrict the permitted support answers in the corresponding PICS.

A.2 Relationship between RL and corresponding PICS proformas

In the context of the profile specification contained in this Standard, PICS proformas of the base protocol standards contain tables in 3 categories. The 3 categories are:

- Those proforma tables where this profile does not restrict the permitted support answers;
- Those proforma tables where this profile restricts the permitted support answers;
- Those proforma tables that are not relevant to this profile.

The Requirements List consists of the tables falling into the second category, with an indication of the modified items in those tables.

A.3 Requirement List

A.3.1 Tables for the physical layer

The profile described by this Standard specifies no additional requirements to those in ECMA-253, ETS 300 290 and ITU-T Recommendation G.728.

A.3.2 Tables for the data link layer (D-channel)

Item number and references refer to annex B of ETS 300 402-4.

A.3.2.1 Major capabilities

Item	Question/Feature	Reference	Protocol Status	Profile Status
MC 2	the unacknowledged information transfer service?	ZA.4.2	o	i
MC 5.1.1	the self initiated establishment of multiple frame operation?	ZA.4.5.1, ZA.4.5.5, ZA.4.5.6	o	m
MC 5.2.1	the self initiated termination of multiple frame operation?	ZA.4.5.2, ZA.4.5.5, ZA.4.5.6	o	m

A.3.2.2 Frames received

Item	Question/Feature	Reference	Protocol Status	Profile Status
FR 12	UI command?	ZA.2.6.5, ZA.4.2	MC 2:m NOT MC2:o	i i

A.3.2.3 Frames transmitted

Item	Question/Feature	Reference	Protocol Status	Profile Status
FT 9	DISC comment?	ZA.2.6.4, ZA.4.5.3	MC 5.2.1:m NOT MC 5.2.1:o	m n/a
FT 12	UI command?	ZA.2.6.5, ZA.4.2	o	i

A.3.3 Tables for the network layer

A.3.3.1 Basic Call (ECMA-143)

Item numbers and references refer to ECMA-143.

A.3.3.1.1 Bearers supported

Item	Question/Feature	Reference	Protocol Status	Profile Status
Z1	Support of the 64 kbps unrestricted bearer	14.5.5	o.1	x (NOTE)
Z2	Support of the 64 kbps bearer with speech transfer capability	14.5.5	o.1	x (NOTE)
Z3	Support of the 64 kbps bearer with 3.1 kHz audio transfer capability	14.5.5	o.1	x (NOTE)
Z4	Support of the Multi-rate Unrestricted Bearer	14.5.5	o.1	x (NOTE)
Z5	Support of A-law User Information layer 1 protocol	14.5.5	(Z2 OR Z3):o.3	i
Z6	Support of μ -law User Information layer 1 protocol	14.5.5	(Z2 OR Z3):o.3	i
Z7	Support of the unrestricted digital information with tones / announcements bearer	14.5.5	o	x
<p><i>NOTE</i> Items Z1 - Z4 are a group of optional items (o.1) that is notionally extended by additional items pD2 and pD3 from the Profile specific ICS (see annex B). Since items pD2 and pD3 have mandatory status in this Profile it is semantically permissible to exclude items Z1- Z4.</p>				

A.3.3.1.2 Status and Status Enquiry protocol procedures

Item	Question/Feature	Reference	Protocol Status	Profile Status
A14	Sending of a STATUS ENQUIRY message	9.3.1	o	x
A15	Receipt of a solicited STATUS message	9.3.2	c.1	i

A.3.3.1.3 Circuit switched call control

Item	Question/Feature	Reference	Protocol Status	Profile Status
B7	Does the implementation include a Sending Complete information element in every generated SETUP message ?	10.1.1	c.3	m
B9	Overlap Receiving procedures	10.1.3	c.4	i
B10	Overlap Sending procedures	10.1.3	c.5	n/a
	Sending of CONNECT ACKNOWLEDGE message	10.1.6	(NOTE)	x
	Support of the Connect Request state and timer T313	10.1.6	(NOTE)	x
B17	Sending of call progress information during call establishment	10.1.7	c.6	m
<p><i>NOTE</i> Item B16 in the PICS proforma includes a note indicating that the use of CONNECT ACKNOWLEDGE and the associated state and timer is optional. There are no specific PICS proforma questions relating to this so they are included here.</p>				

A.3.3.1.4 Procedures for layer management

Item	Question/Feature	Reference	Protocol Status	Profile Status
H1	Initiation of Restart procedures - All channels	11.1.1	o	m
H2	Initiation of Restart procedures - Multiple channels	11.1.1	Z4:o	x
H3	Initiation of Restart procedures - Single channels	11.1.1	o	x

A.3.3.1.5 Timers

Item	Question/Feature	Reference	Protocol Status	Profile Status
I1	Implementation of T301	12	c.7	m
I9	Implementation of T313	12	c.11	x

A.3.3.1.6 Messages and information elements for general procedures

Item	Question/Feature	Reference	Protocol Status	Profile Status
J4	Sending of a Sending Complete information element in an INFORMATION message when overlap sending is complete	13.2.6	o	n/a
J5	Sending of a Progress Indicator information element in an ALERTING message (except when relaying at a Transit PINX in accordance with C4)	13.2.1	o	m
J6	Sending of a Progress Indicator information element in a CONNECT message (except when relaying at a Transit PINX in accordance with C4)	13.2.3	o	m
J12	Sending of a Sending Complete information element in a SETUP message when enbloc sending	13.2.10	o	m
J13	Sending of a Progress Indicator information element in a SETUP message (except when relaying at a Transit PINX in accordance with C4)	13.2.10	o	m
J14	Sending of a Calling Party Number information element in a SETUP message (except when relaying at a Transit PINX in accordance with C4)	13.2.10	o	m
J20	Sending of a Channel Identification information element in a RESTART ACKNOWLEDGE message	13.3.2	o	n/a
J21	Support of channel map	14.5.12	o	x
J23	Type of number supported for Private Numbering Plan: Unknown Level 2 regional number Level 1 regional number PISN specific number Level 0 regional number Abbreviated number	14.5.7	o	x x x m x x

A.3.3.1.7 Message segmentation / re-assembly procedures

Item	Question/Feature	Reference	Protocol Status	Profile Status
K3	Is length of signalling carriage mechanism information field < max. generated message size	ZA.3	o	x
K4	Is length of signalling carriage mechanism information field < max. received message size	ZA.3	o	x
K5	Procedures for messages segmentation	ZA.3.1	c.12	x

A.3.3.1.8 Party category functionality

Item	Question/Feature	Reference	Protocol Status	Profile Status
N1	Party category functionality	ZC.2	o	x

A.3.3.2 Generic Functional Protocol

Item numbers refer to annex A of ECMA-165.

A.3.3.2.1 Call related protocol control and GFT-Control requirements

Item	Question/Feature	Reference	Protocol Status	Profile Status
A1	Can the implementation act as a Source PINX for APDUs?	7.1.1.1	o	m
A12	Can the implementation generate notification information?	7.4	o	m

A.3.3.2.2 Connectionless ADPU transport mechanism

Item	Question/Feature	Reference	Protocol Status	Profile Status
B1	Does the PINX support Connectionless APDU transport?	7.2	o	x

A.3.3.2.3 Connection oriented APDU transport mechanism

Item	Question/Feature	Reference	Protocol Status	Profile Status
C1	Does the PINX support connection-oriented APDU transport?	7.3	o	m
C2	Can the implementation act as a Source PINX for APDUs when supporting the Connection oriented APDU transport mechanism?	7.3	C1:o	m
C4	Actions at an Originating PINX	7.3.3.1	C1:o	m
C6	Actions at a Terminating PINX	7.3.3.3	C1:o	m

A.3.3.2.4 Coordination Function requirements

Item	Question/Feature	Reference	Protocol Status	Profile Status
D1	Inclusion of an Interpretation APDU at a Source PINX	8.1.1	o	m

A.3.3.2.5 ACSE and DSE requirements

Item	Question/Feature	Reference	Protocol Status	Profile Status
G1	Does implementation support the ACSE protocol?	8.3	o	x
F1	Does implementation support the DSE protocol?	8.4	o	x

A.3.3.2.6 Implemented parameters

A.3.3.2.6.1 ALERTING message

Item	Question/Feature	Reference	Protocol Status	Profile Status
J1	Facility information element - Orig	10.1, 11.3.3	A1:o.3	m
J3	Notification indicator information element - Orig	10.1, 11.3.4	A12:o.4	m

A.3.3.2.6.2 CONNECT message

Item	Question/Feature	Reference	Protocol Status	Profile Status
K1	Facility information element - Orig	10.3, 11.3.3	c.2	m
K3	Notification indicator information element - Orig	10.3, 11.3.4	A12:o.4	m

A.3.3.2.6.3 SETUP message

Item	Question/Feature	Reference	Protocol Status	Profile Status
L1	Facility information element - Orig	10.4, 11.3.3	c.2	m
L3	Notification indicator information element - Orig	10.4, 11.3.4	A12:o.4	m
L5	Transit counter information element - Orig	7.3.1.1, 6.3 of ECMA-225	o	m

A.3.3.2.6.4 DISCONNECT message

Item	Question/Feature	Reference	Protocol Status	Profile Status
M1	Facility information element - Orig	10.5, 11.3.3	A1:o.3	m
M3	Notification indicator information element - Orig	10.5, 11.3.4	A12:o.4	m

A.3.3.2.6.5 RELEASE message

Item	Question/Feature	Reference	Protocol Status	Profile Status
N1	Facility information element - Orig	10.6, 11.3.3	c.2	m

A.3.3.2.6.6 RELEASE COMPLETE message

Item	Question/Feature	Reference	Protocol Status	Profile Status
O1	Facility information element - Orig	10.7, 11.3.3	c.2	m

A.3.3.2.6.7 FACILITY message

Item	Question/Feature	Reference	Protocol Status	Profile Status
P1	FACILITY message - Orig	10.8	c.3	m
P14	Notification indicator information element - Orig	10.8, 11.3.4	c.4	m

A.3.3.2.6.8 NOTIFY message

Item	Question/Feature	Reference	Protocol Status	Profile Status
Q1	NOTIFY message - Orig	10.9	A12:o.4	m

A.3.3.2.6.9 PROGRESS message

Item	Question/Feature	Reference	Protocol Status	Profile Status
R1	Facility information element - Orig	10.10, 11.3.3	A1:o.3	m
R3	Notification indicator information element - Orig	10.10, 11.3.4	A12:o.4	m

A.3.4 Tables for Supplementary Services and ANFs

A.3.4.1 Call intrusion

Item numbers refer to annex A of ECMA-203.

A.3.4.1.1 General

Item	Question/Feature	Reference	Protocol Status	Profile Status
A1	Support of SS-CI in Originating PINX of an intruding call	6.6.1	o.1	m
A2	Support of SS-CI in Terminating PINX of an intruding call	6.6.2	o.1	m
A3	Support of SS-CI in Unwanted User PINX	6.6.3	o	o
A4	Behaviour as gateway to support SS-CI from user in PISN to user in public ISDN	6.7	o	x
A5	Behaviour as gateway to support SS-CI from user in PISN to user in other network (i.e., R2)	6.8	o	m
A6	Behaviour as gateway to support SS-CI from user in other network (i.e., R2) to user in PISN	6.8	o	m
A7	Behaviour as gateway to support CIPL request from Terminating PINX to another network	6.8	o	m
A8	Behaviour as gateway to support CIPL request from another network to an Unwanted User PINX	6.8	o	m

A.3.4.1.2 Procedures

Item	Question/Feature	Reference	Protocol Status	Profile Status
B1	Support of relevant ECMA-143 and ECMA-165 procedures	6.2.1, 6.2.2, 6.2.3	m	m
B2	SS-CI invocation without path retention in Originating PINX	6.6.1.1, 6.6.1.6	A1:o.2	m
B3	SS-CI invocation with path retention in Originating PINX	6.6.1.1, 6.6.1.6, A.2.1, A.5.1	A1:o.2	x
B4	SS-CI invocation without path retention in Terminating PINX	6.6.2.1, 6.6.2.6	A2:m	m
B5	SS-CI invocation with path retention in Terminating PINX	6.6.2.1, 6.6.2.6, A.2.2, A.5.2	A2:m	m (NOTE)
B6	Notification of intrusion impending in Terminating PINX	6.6.2	A2:o	m
B7	Notification of intrusion to calling user in Terminating PINX	6.6.2	B6:o	m
B8	Forced release request in Originating PINX	6.6.1.3	A1:o	x
B9	Forced release request in Terminating PINX	6.6.2.3	A2:o	x
B10	Isolate request in Originating PINX	6.6.1.2	A1:o	x
B11	Isolate request in Terminating PINX	6.6.2.2	A2:o	x
B12	Wait on busy request in Originating PINX	6.6.1.4	A1:o	x
B13	Wait on busy request in Terminating PINX	6.6.2.4	A2:o	x
B14	Reinvocation of SS-CI after wait on busy in Originating PINX	6.6.1.4	B12:m	x
B15	Reinvocation of SS-CI after wait on busy in Terminating PINX	6.6.2.4	B13:m	x
B16	SS-CI invocation in Unwanted User PINX	6.6.3	A3:m	m

NOTE

The use of the path retention mechanism is not envisaged in the ATS application. A PINX conforming to this specification need not, therefore, support the associated states and procedures. However, not supporting the states and procedures on the terminating side may be considered as a non-compliance in any formal exercise to assess conformity with ECMA-203. Additionally, support of the states and procedures on the terminating side improves the possibility of achieving interoperability in the case where a PINX receives a SETUP message containing a pathRetain invoke APDU.

A.3.4.1.3 Coding

Item	Question/Feature	Reference	Protocol Status	Profile Status
C1	Sending of callIntrusionRequest invoke APDU and receipt of callIntrusionRequest return result and error APDU in Originating PINX	6.3.1	A1:m	m
C2	Sending of pathRetain invoke APDU and receipt of serviceAvailable invoke APDU in Originating PINX	6.3.1	B3:m	n/a
C3	Receipt of callIntrusionRequest invoke APDU and sending of callIntrusionRequest return result and error APDU in Terminating PINX	6.3.1	A2:m	m
C4	Receipt of pathRetain invoke APDU and sending of serviceAvailable invoke APDU in Terminating PINX	6.3.1	A2:m	m (NOTE)
C5	Sending of callIntrusionGetCIPL invoke APDU and receipt of callIntrusionGetCIPL return result APDU in Terminating PINX	6.3.1	A2:m	m
C6	Receipt of callIntrusionGetCIPL invoke APDU and sending of callIntrusionGetCIPL return result APDU in Unwanted User PINX	6.3.1	A3:m	m
C7	Sending of callIntrusionForcedRelease invoke APDU and receipt of callIntrusionForcedRelease return result APDU in Originating PINX	6.3.1	B8:m	n/a
C8	Receipt of callIntrusionForcedRelease invoke APDU and sending of callIntrusionForcedRelease return result APDU in Terminating PINX	6.3.1	B9:m	n/a
C9	Sending of callIntrusionIsolate invoke APDU and receipt of callIntrusionIsolate return result APDU in Originating PINX	6.3.1	B10:m	n/a
C10	Receipt of callIntrusionIsolate invoke APDU and sending of callIntrusionIsolate return result APDU in Terminating PINX	6.3.1	B11:m	n/a
continued ...				

Item	Question/Feature	Reference	Protocol Status	Profile Status
C11	Sending of callIntrusionWOBRequest invoke APDU and receipt of callIntrusionWOBRequest return result APDU in Originating PINX	6.3.1	B12:m	n/a
C12	Receipt of callIntrusionWOB invoke APDU and sending of callIntrusionWOBRequest return result APDU in Terminating PINX	6.3.1	B13:m	n/a
C13	Receipt of callIntrusionCompleted invoke APDU in Originating PINX	6.3.1	A1:m	m
C14	Sending of callIntrusionCompleted invoke APDU in Terminating PINX	6.3.1	A2:m	m
<p><i>NOTE</i> See note attached to PICS item B5 in subclause A.3.4.1.2.</p>				

A.3.4.1.4 Timers

Item	Question/Feature	Reference	Protocol Status	Profile Status
D1	Support of timer T1	6.10	A2:m	m
D2	Support of timer T2	6.10	B10:m	n/a
D3	Support of timer T3	6.10	B8:m	n/a
D4	Support of timer T4	6.10	B12:m	n/a
D5	Support of timer T5	6.10	A2:m	m
D6	Support of timer T6	6.10	B6:m	m
D7	Support of timer PRT1	A.8	A2:m	m (NOTE)
<p><i>NOTE</i> See footnote attached to PICS item B5.</p>				

A.3.4.2 Call priority interruption (protection)

Item numbers refer to annex A of ECMA-264.

A.3.4.2.1 General

Item	Question/Feature	Reference	Protocol Status	Profile Status
A1	Support of SS-CPI		o.1	m
A2	Support of SS-CPIP		o.1	m
A3	Support of SS-CPI in Originating PINX	6.8.1	A1:o.2	m
A4	Support of SS-CPI in Transit PINX	6.8.2	A1:o.2	m
A6	Support of SS-CPIP in Originating PINX	6.9.1	A2:o.3	m
A7	Support of SS-CPIP in Transit PINX	6.9.2	A2:o.3	m
A8	Support of SS-CPIP in Terminating PINX	6.9.3	A2:o.3	m
A9	SS-CPI behaviour as Incoming Gateway when interworking with public ISDN	6.10	A1:o	m
A10	SS-CPI behaviour as Incoming Gateway when interworking with non-ISDNs	6.12	A1:o	m
A11	SS-CPI behaviour as Outgoing Gateway when interworking with non-ISDNs	6.12	A1:o	m
A12	SS-CPIP behaviour as Incoming Gateway when interworking with public ISDN	6.11	A2:o	m
A13	SS-CPIP behaviour as Outgoing Gateway when interworking with public ISDN	6.11	A2:o	m
A14	SS-CPIP behaviour as Incoming Gateway when interworking with non-ISDNs	6.13	A2:o	m
A15	SS-CPIP behaviour as Outgoing Gateway when interworking with non-ISDNs	6.13	A2:o	m

A.3.4.2.2 Procedures

Item	Question/Feature	Reference	Protocol Status	Profile Status
B5	Notification of interruption impending in Interrupting PINX	6.8.3	A5:o	m
B9	SS-CPIP procedures in Terminating PINX - backward direction	6.9.3	A8:o	x

A.3.4.3 Transit counter

Item numbers refer to annex A of ECMA-225.

A.3.4.3.1 General

Item	Question/Feature	Reference	Protocol Status	Profile Status
A1	Behaviour as an Originating PINX for ANF-TC in association with basic circuit switched call control	6.2.1, 6.4.1	o.1	m
A2	Behaviour as an Originating PINX for ANF-TC in association with call independent signalling connections	6.2.1, 6.4.1	o.1	m
A3	Behaviour as a Terminating PINX for ANF-TC in association with basic circuit switched call control	6.2.2, 6.4.2	o.1	m
A4	Behaviour as a Terminating PINX for ANF-TC in association with call independent signalling connections	6.2.2, 6.4.2	o.1	m
A5	Behaviour as a Transit PINX for ANF-TC in association with basic circuit switched call control	6.2.3, 6.4.3	o.1	m
A6	Behaviour as a Transit PINX for ANF-TC in association with call independent signalling connections	6.2.3, 6.4.3	o.1	m
A7	Behaviour as an Incoming Gateway PINX for ANF-TC in association with basic circuit switched call control	6.4.4	o.1	m
A8	Behaviour as an Incoming Gateway PINX for ANF-TC in association with call independent signalling connections	6.4.4	o.1	m
A9	Behaviour as an Outgoing Gateway PINX for ANF-TC in association with basic circuit switched call control	6.4.5	o.1	m
A10	Behaviour as an Outgoing Gateway PINX for ANF-TC in association with call independent signalling connections	6.4.5	o.1	m

Annex B

(normative)

Profile specific ICS proforma

B.1 General

The layout and content of this annex is guided by ISO/IEC 9646-7.

The supplier of a profile implementation that is claimed to conform to this Standard shall complete the Profile specific Implementation Conformance Statement (ICS) proforma contained in this annex.

NOTE

The supplier is also required to complete a copy of the PICS proformas provided in each of the protocol standards referred to by this Standard.

A completed Profile specific ICS proforma is the ICS for the implementation in question. The ICS is a statement of which capabilities and options of the profile have been implemented. The ICS can have a number of uses, including use:

- By the profile implementer, as a check list to reduce the risk of failure to conform to the standard through oversight;
- By the supplier and acquirer (or potential acquirer) of the implementation, as a detailed indication of the capabilities of the implementation, stated relative to the common basis for understanding provided by the standard ICS proforma;
- By the user (or potential user) of the implementation, as a basis for initially checking the possibility of interworking with another implementation (note that, while interworking cannot be guaranteed, failure to interwork can often be predicted from incompatible ICS);
- By a protocol tester, as the basis for selecting appropriate test suites against which to assess the claim for conformance of the implementation.

B.2 Instruction for completing the ICS proforma

B.2.1 General structure of the ICS proforma

The ICS proforma is a fixed format questionnaire divided into subclauses each containing a group of individual items. Each item is identified by an item number, the name of the item (question to be answered), and the reference(s) to either the base standard, or a specific clause in a base standard, or specifying the item in the main body of this Standard (if no base standard is listed in the reference column).

The "Status" column indicates whether an item is applicable and if so whether support is mandatory or optional. The following terms are used:

- m mandatory (the capability is required for conformance to the profile);
- o optional (the capability is not required for conformance to the profile but if the capability is implemented it is required to conform to the profile specification);
- o.<n> optional, but support of at least one of the group of options labelled by the same numeral <n> is required;
- <item>:m simple-conditional requirement, the capability being mandatory if item number <item> is supported, otherwise not applicable;
- <item>:o simple-conditional requirement, the capability being optional if item number <item> is supported, otherwise not applicable;

x prohibited;

c.<cond> conditional requirement, depending on support for the item listed in condition <cond>.

Answers to the questionnaire items are to be provided in the "Support" column, by simply marking an answer to indicate a restricted choice (Yes or No), or in the "Not Applicable" column (N/A).

B.2.2 Additional Information

Items of Additional information allow a supplier to provide further information intended to assist the interpretation of the ICS. It is not intended or expected that a large quantity will be supplied, and an ICS can be considered complete without any such information. Examples might be an outline of the ways in which a (single) implementation can be set up to operate in a variety of environments and configurations.

References to items of Additional information may be entered next to any answer in the questionnaire, and may be included in items of Exception Information.

B.2.3 Exception Information

It may occasionally happen that a supplier will wish to answer an item with mandatory or prohibited status (after any conditions have been applied) in a way that conflicts with the indicated requirements. No pre-printed answer will be found in the Support column for this. Instead, the supplier is required to write into the support column an x.<i> reference to an item of Exception Information, and to provide the appropriate rationale in the Exception item itself.

An implementation for which a Exception item is required in this way does not conform to this Standard. A possible reason for the situation described above is that a defect in the standard has been reported, a correction for which is expected to change the requirement not met by the implementation.

B.3 ICS proforma

B.3.1 Implementation Identification

Supplier	
Contact point for queries about the ICS	
Implementation Name(s) and Version(s) (NOTE)	
Other information necessary for full identification, e.g. name(s) and version(s) for machines and/or operating systems; system name(s)	
Have any exception items been required?	No[] Yes[] (The answer Yes means that the implementation does not conform to this Standard)
Date of Statement	

NOTE

The terms "Name" and "Version" should be interpreted appropriately to correspond with a suppliers terminology (e.g., Type, Series, Model).

B.3.2 Supported interfaces and protocols

Item	Question/Feature	Reference	Status	N/A	Support
pA1	Support of LD-CELP voice encoding (G.728)?	8.1	m		Yes[]
pA2	Support of 64kbps interface (ETS 300 290)?	9.1.1	m		Yes[]
pA3	Support of 4 x 16kbps sub-multiplexing (ECMA-253)?	9.1.2	m		Yes[]
pA4	Support of ETS 300 402-2 annex ZA?	9.2.1	m		Yes[]
pA5	Support of PSS1 (QSIG) Basic Call procedures (ECMA-143)?	10.1 - 10.18, 11	m		Yes[]
pA6	Support of PSS1 (QSIG) Generic Functional Protocol (ECMA-165)?	10.19	m		Yes[]
pA7	Support of SS-CPI(P) (ECMA-264)?	10.20, 10.21	m		Yes[]
pA8	Support of SS-CI (ECMA-203)?	10.20, 10.21	m		Yes[]
pA9	Support of ANF-TC (ECMA-225)?	10.20, 10.22	m		Yes[]

B.3.3 Physical layer

Item	Question/Feature	Reference	Status	N/A	Support
pB1	Support of AIS?	9.1.3	m		Yes[]
pB2	Support of synchronisation functions?	9.1.4	m		Yes[]
pB3	G.728 bit stealing method for synchronising LD-CELP bitstream?	8.1	m		Yes[]
pB4	No decompression at a Transit PINX?	8.1	m		Yes[]
pB5	Octet synchronisation procedure?	9.3	m		Yes[]

B.3.4 Data link layer

Item	Question/Feature	Reference	Status	N/A	Support
pC1	Means of configuring PINX as "master" or "slave" side?	9.2.1	m		Yes[]
pC2	Transmission of continuous flags between L2 frames?	9.2.1	m		Yes[]
pC3	Every L2 frame has its own opening and closing flags?	9.2.1	m		Yes[]
pC4	Means of configuring L2 parameters?	9.2.1	m		Yes[]
pC5	Support of default values of L2 parameters?	9.2.1	m		Yes[]

B.3.5 Network layer (Basic Call)

Item	Question/Feature	Reference	Status	N/A	Support
pD1	Call request and transmission of the SETUP message?	10.5	m		Yes[]
pD2	Support of the 16kbps unrestricted bearer?	10.5, 10.17.2, ECMA-253 annex C	m		Yes[]
pD3	Support of the 16kbps bearer with speech capability?	10.5, 10.17.2, ECMA-253 annex C	m		Yes[]
pD4	Support of G.728 LD-CELP User Information layer 1 protocol?	8.1, 10.17.2, ECMA-253 annex C	m		Yes[]
pD5	Support of 6 digit PISN specific numbers?	10.5, 10.17.4, 10.17.5	m		Yes[]
pD6	Information channel selection and binary channel numbers?	10.6, 10.17.7	m		Yes[]
pD7	Agreement of channel and call proceeding?	10.7	m		Yes[]
pD8	Call confirmation indication?	10.8	m		Yes[]
pD9	Call connected?	10.9	m		Yes[]
pD10	Use of the PROGRESS message?	10.10	m		Yes[]
pD11	Call clearing and cause coding?	10.12, 10.17.6	m		Yes[]
pD12	Call collisions?	10.13	m		Yes[]
pD13	Simultaneous call attempts (procedure specified in annex C)?	10.14	o		Yes[] No[]
pD14	Alternative routing?	10.15	m		Yes[]
pD15	Timer values?	10.16	m		Yes[]
pD16	Restart procedures?	10.18	m		Yes[]

B.3.6 Network layer (Generic Functional Protocol)

Item	Question/Feature	Reference	Status	N/A	Support
pE1	Coding of information elements?	10.19.2	m		Yes[]
pE2	Integer encoding of operation values?	10.19.3	m		Yes[]

B.3.7 Priority interruption and intrusion supplementary services

Item	Question/Feature	Reference	Status	N/A	Support
pF1	Call control procedures?	10.21.2	m		Yes[]
pF2	Invocation of priority functions at an Originating PINX?	10.21.3	m		Yes[]
pF3	Execution of SS-CPI?	10.21.4	m		Yes[]

B.3.8 Transit counter ANF

Item	Question/Feature	Reference	Status	N/A	Support
pG1	Means of configuring maximum value the transit count field can reach?	10.22	m		Yes[]

Annex C

(normative)

Procedures for detecting and resolving Simultaneous Call Attempts on a single Inter-PINX Link

C.1 General

A simultaneous call attempt exists when user A attempts to call user B at the same time as user B attempts to call user A.

This annex describes one method of detecting and resolving simultaneous call attempts occurring on a single Inter-PINX Link. It covers cases involving call collision and calls of unequal priority as well as the "normal" case between two calls of equal priority and without call collision.

Clause C.2 specifies the procedure and clause C.3 illustrates it using the Specification and Description Language defined in ITU-T Rec. Z.100 (1993).

Support of these procedures is optional.

C.2 Description of procedure

C.2.1 Detection of a simultaneous call attempt

When a Terminating PINX processes an incoming call that encounters the user busy condition, some additional checks may be made in order to detect a simultaneous call attempt. Firstly, the Terminating PINX shall ensure that the call in progress at the required (busy) destination is not in either an Alerting or Active state but in an outgoing call establishment state. Secondly, the Terminating PINX shall determine if the calling party number and called party number of the busy destination's outgoing call are the reciprocal of those for the incoming call being processed. If both these conditions exist the PINX shall assume that a simultaneous call attempt is in progress.

Once a simultaneous call attempt has been detected further tests shall be made to determine whether a call collision is involved or not, and whether the involved calls are of equal or unequal priority. The simultaneous call attempt can be resolved according to the appropriate procedures specified in one of the following subclauses.

C.2.2 Calls without call collision

The following procedure shall apply when no call collision has occurred:

- 1) The Terminating PINX shall compare the numerical values of the party numbers of the two parties involved in the simultaneous call attempts;
- 2) The PINX determining that the numerical value of the Calling party number associated with its outgoing call is "greater than" the numerical value of the Calling party number of the incoming call shall reject the incoming QSIG call and shall continue with the establishment of its own outgoing QSIG call; and,
- 3) The PINX determining that the numerical value of the Calling party number associated with its outgoing call is "less than" the numerical value of the Calling party number of the incoming call shall:
 - a) Clear its own outgoing QSIG call;
 - b) If the B-channel proposed in the incoming SETUP indication is acceptable, through-connect this B-channel to the TE function, or if the B-channel proposed in the incoming SETUP indication is not acceptable (e.g., because of a fault condition) through-connect an alternative B-channel;

- c) Send a CONNECT message to accept the incoming QSIG call; this CONNECT message shall contain an indication of the B-channel to be used;
- d) Cause an "answer signal" to be sent to the TE function that initiated the outgoing call; and,
- e) Enter the call into the Active state.

C.2.3 Calls of equal priority and call collision

The following procedure shall apply when both calls are of equal priority and call collision has also occurred:

- 1) The PINX configured as the "A" side for the inter-PINX link on which the collision occurred shall reject the incoming QSIG call and shall continue with the establishment of its own outgoing QSIG call; and,
- 2) The PINX configured as the "B" side for the inter-PINX link on which the collision occurred shall:
 - a) Clear its own outgoing QSIG call;
 - b) If the B-channel proposed in the incoming SETUP indication is acceptable, through-connect this B-channel to the TE function, or if the B-channel proposed in the incoming SETUP indication is not acceptable (e.g., because of a fault condition) through-connect an alternative B-channel;
 - c) Send a CONNECT message to accept the incoming QSIG call; this CONNECT message shall contain an indication of the B-channel to be used;
 - d) Cause an "answer signal" to be sent to the TE function that initiated the outgoing call; and,
 - e) Enter the call into the Active state.

C.2.4 Calls of unequal priority and call collision

The following procedure shall apply when the two calls are of unequal priority and call collision has also occurred:

- 1) The PINX that originated the QSIG call with the higher priority shall reject the incoming QSIG call and shall continue with the establishment of its own outgoing QSIG call.
- 2) The PINX that originated the QSIG call with the lower priority shall:
 - a) Clear its own outgoing QSIG call;
 - b) If the B-channel proposed in the incoming SETUP indication is acceptable, through-connect this B-channel to the TE function, or if the B-channel proposed in the incoming SETUP indication is not acceptable (e.g., because of a fault condition) through-connect an alternative B-channel;
 - c) Send a CONNECT message to accept the incoming QSIG call; this CONNECT message shall contain an indication of the B-channel to be used;
 - d) Cause an "answer signal" to be sent to the TE function that initiated the outgoing call; and,
 - e) Enter the call into the Active state.

C.3 Specification and Description Language (SDL) representation of procedures

Figure C.1 shows the behaviour of a process (SCA) for detecting and resolving Simultaneous Call Attempts. Figures C.2 and C.3 show the definitions of the SDL macros used. The diagrams illustrate the behaviour of a part of a PINX. They are not normative and are not intended to be exhaustive or to imply a particular implementation.

Input signals from the left and output signals to the left represent primitives from and to the Protocol Control Function in respect of Basic Call messages received from and sent to a peer PINX.

Output signals to the right represent primitives to the user (or an entity acting on behalf of the user), or to the Call Control entity associated with another call handled by the same PINX.

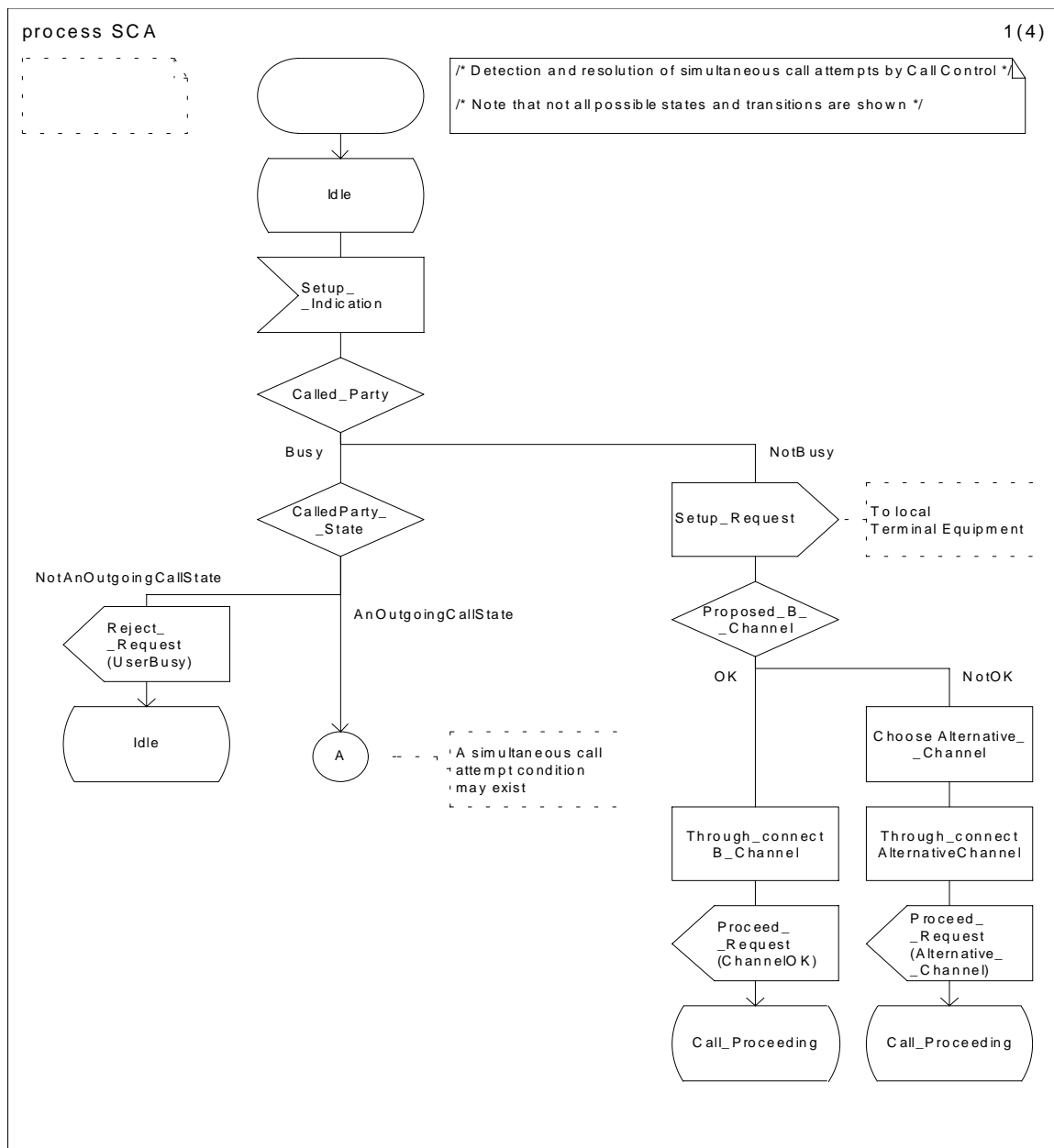

Figure C.1 (sheet 1 of 4) - SDL for the detection and resolution of simultaneous call attempts

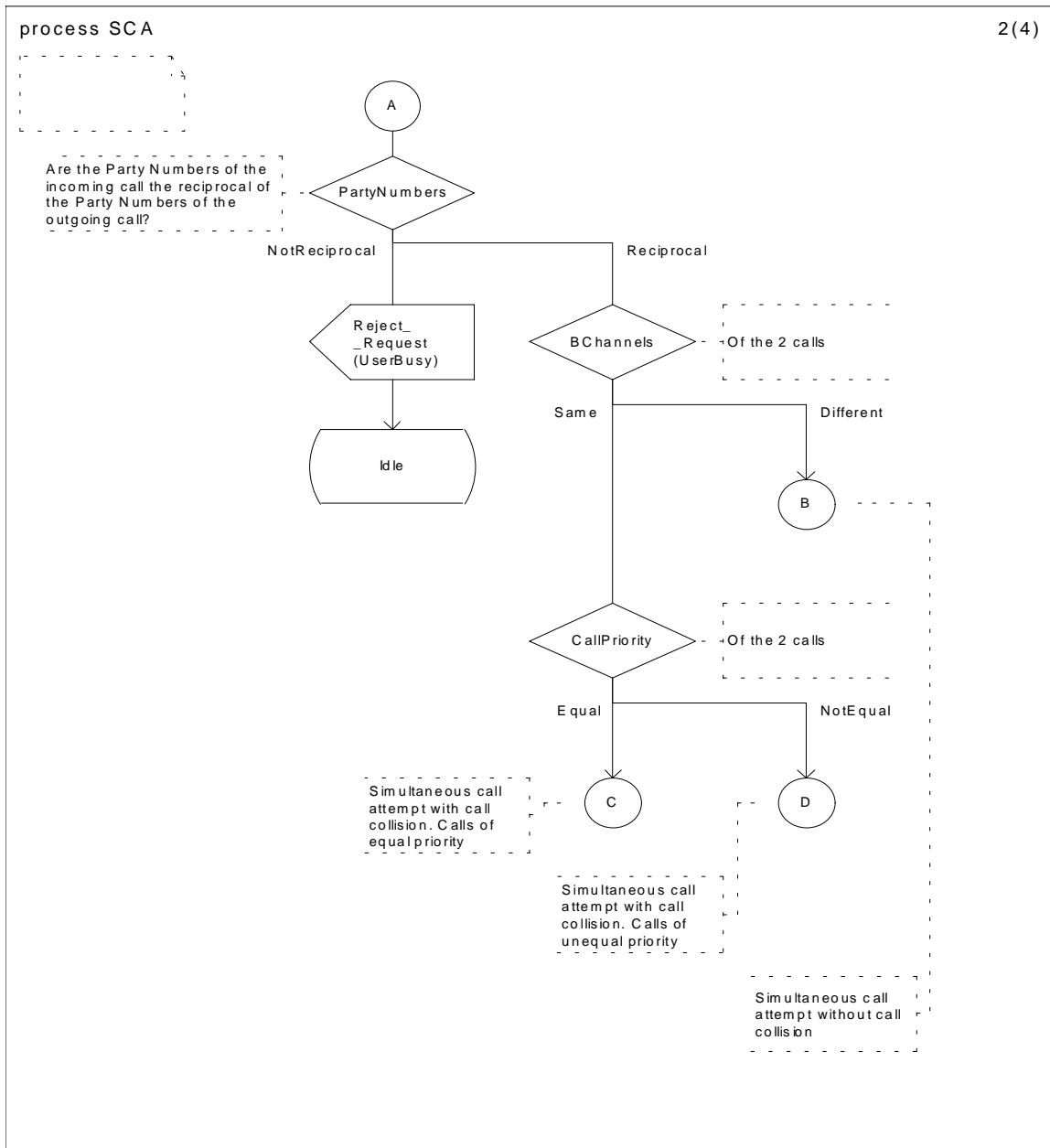

Figure C.1 (sheet 2 of 4) - SDL for the detection and resolution of simultaneous call attempts

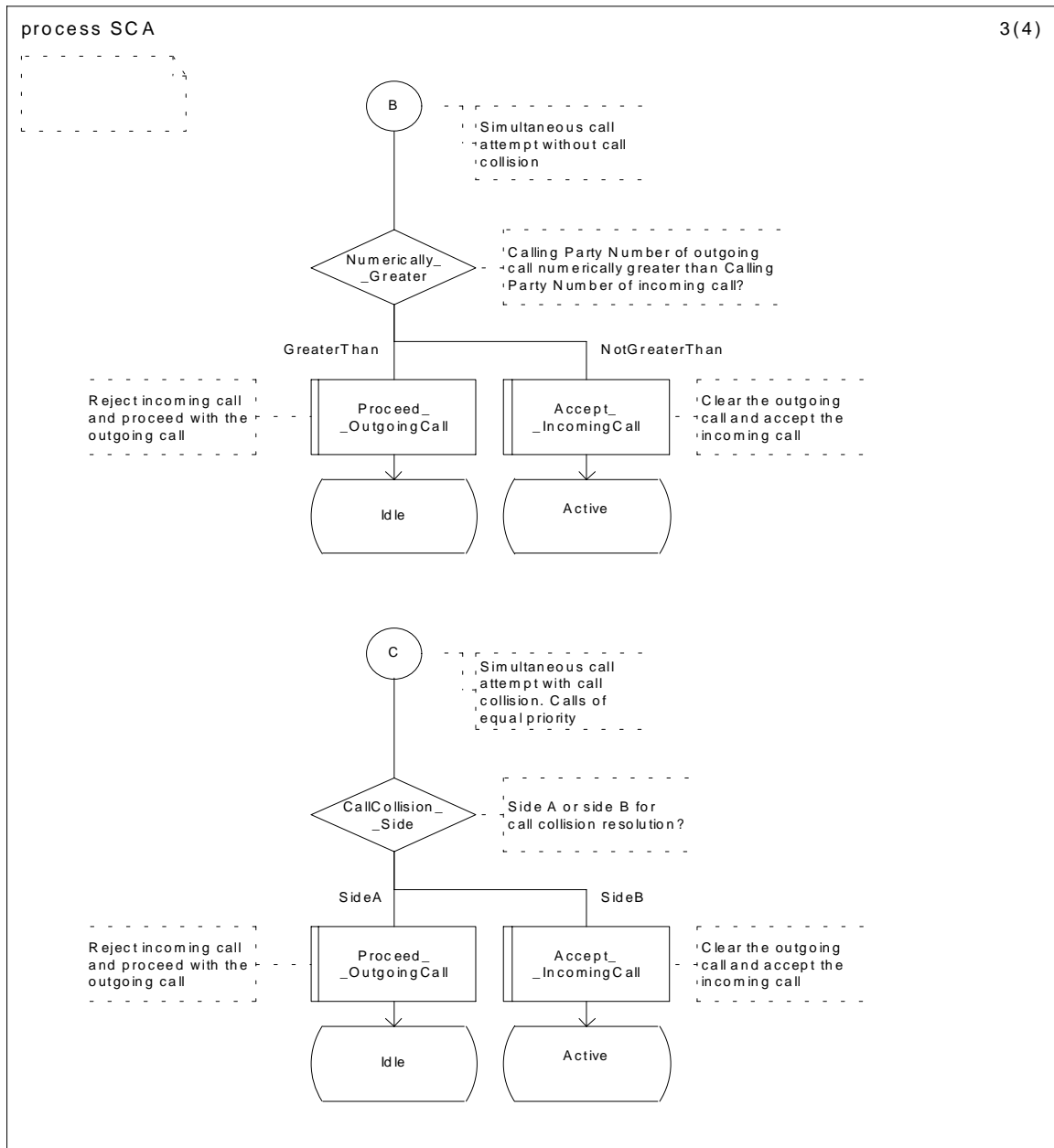

Figure C.1 (sheet 3 of 4) - SDL for the detection and resolution of simultaneous call attempts

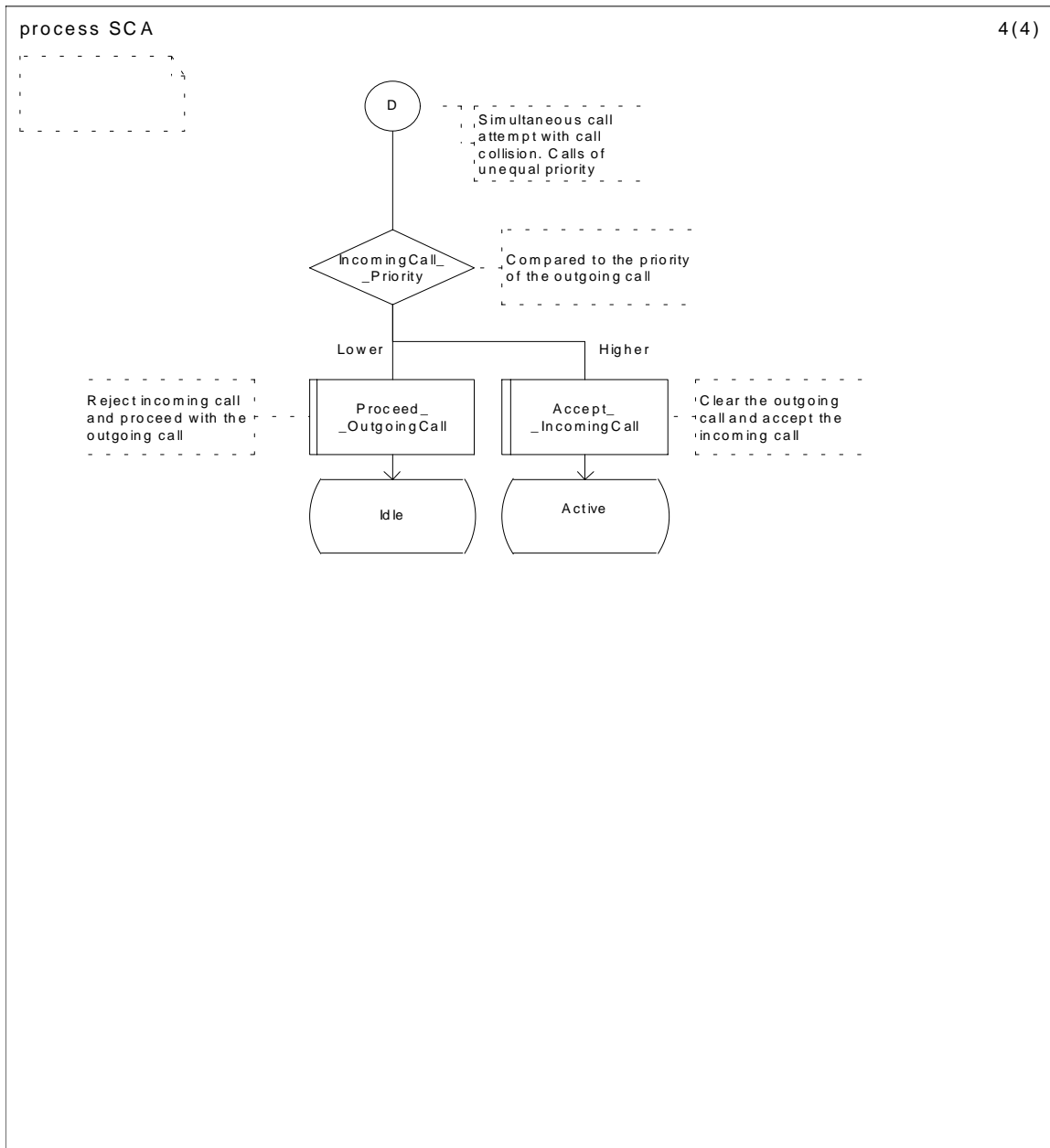

Figure C.1 (sheet 4 of 4) - SDL for the detection and resolution of simultaneous call attempts

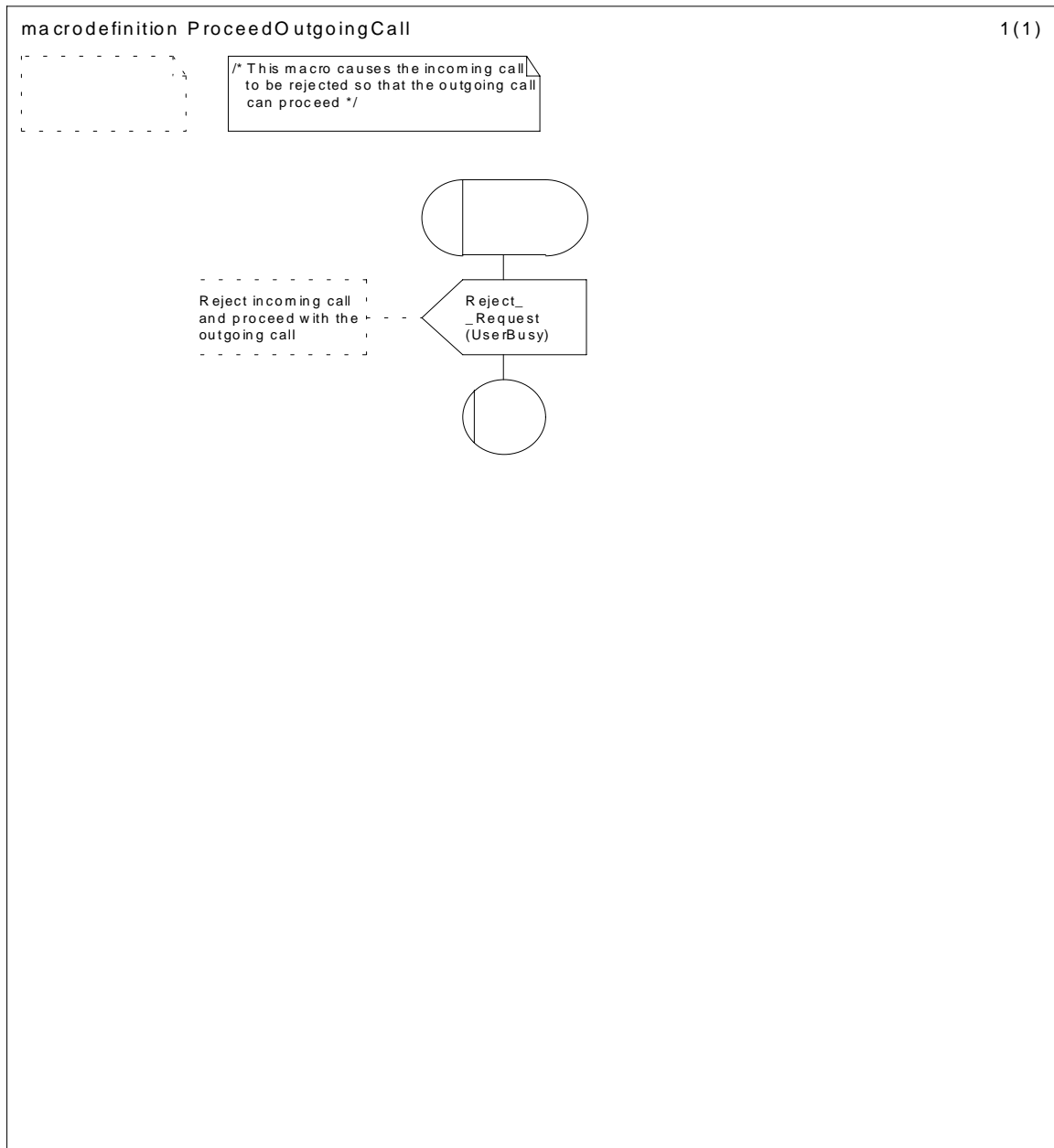

Figure C.2 (sheet 1 of 1) - SDL macro definition ProceedOutgoingCall

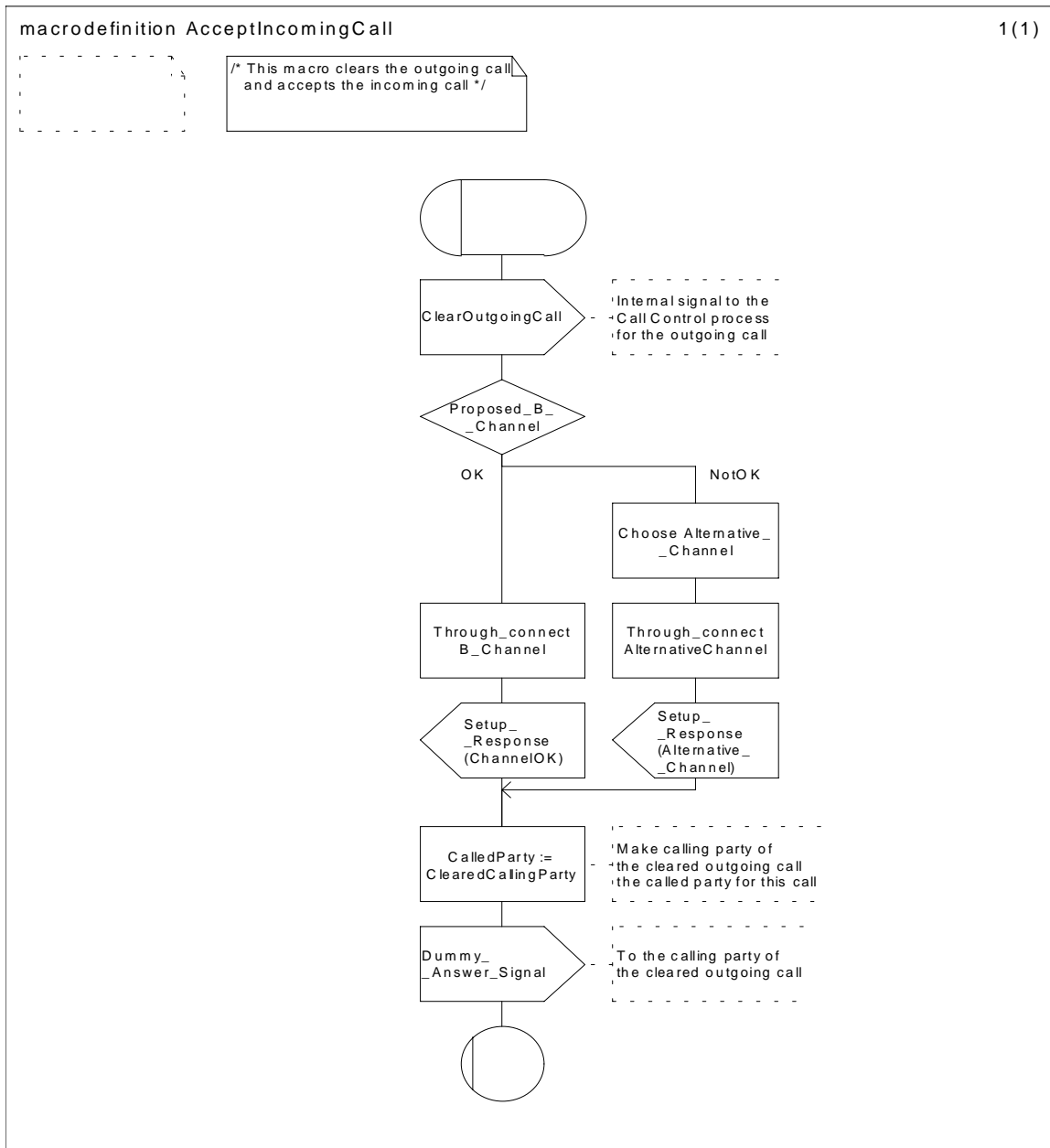

Figure C.3 (sheet 1 of 1) - SDL macro definition AcceptIncomingCall

Annex D
(informative)

Facility information element contents encoding

D.1 General

This annex contains example encodings of the contents of the Facility information element for each of the operations, errors and notifications used by the supplementary services specified for use in ATS PISNs (i.e., for the Call intrusion (SS-CI), Call priority interruption (SS-CPI) and Call priority interruption protection (SS-CPIP) supplementary services).

NOTE

The examples in this annex show the InvokeID parameter to be a single octet integer (i.e., in the range -127 .. +127). However, implementations must be capable of processing received InvokeID parameters in the range -32768 .. +32767 (see ECMA-165, table 34).

D.2 callIntrusionRequest invoke (ciRequest.inv) operation

Figure D.1 shows the encoding of the callIntrusionRequest (ciRequest.inv) invoke operation.

STRUCTURE	CODING	REMARKS
Facility IE	1Ch	
Length of Facility IE	16h	
Protocol Profile="Network Extensions" (1Fh)	9Fh	
Network Facility Extension IE (10)	AAh	
Length of Network Facility Extension IE	06h	
Source Entity	80h	
Length	01h	
source entity = "endPINX" (0)	00h	
Destination Entity (2)	82h	
Length	01h	
destination entity = "endPINX" (0)	00h	
Invoke PDU [1]	A1h	
Length of invoke PDU	0Bh	
InvokeIDtype (integer)	02h	
Length	01h	
InvokeID	xxh	00h-FFh (NOTE in subclause C.1)
Operation (integer)	02h	
Length	01h	
0 operation Value="ci-request" (43)	2Bh	
Argument (sequence)	30h	
Length	03h	
CicapabilityLevel (enum)	0Ah	
Length	01h	
ciCapabilityLevel="intrusionHighProt"	03h	

Figure D.1 - Encoding of callIntrusionRequest invoke operation

D.3 callIntrusionRequest result (ciRequest.res) operation

Figure D.2 shows the encoding of the callIntrusionRequest result (ciRequest.res) operation.

STRUCTURE	CODING	REMARKS
Facility IE	1Ch	
Length of Facility IE	18h	
Protocol Profile="Network Extensions" (1Fh)	9Fh	
Network Facility Extension IE (10)	AAh	
Length of Network Facility Extension IE	06h	
Source Entity	80h	
Length	01h	
source entity = "endPINX" (0)	00h	
Destination Entity (2)	82h	
Length	01h	
destination entity = "endPINX" (0)	00h	
ReturnResultPDU [2]	A2h	
Length of ReturnResultPDU	0Dh	
InvokeIDtype (integer)	02h	
Length	01h	
InvokeID	xxh	00h-FFh (NOTE in subclause C.1)
Sequence	30h	
Length	08h	
Operation (integer)	02h	
Length	01h	
0 operation Value="ci-request" (43)	2Bh	
Result (sequence)	30h	
Length	03h	
CIUnwantedUserStatus (enum)	0Ah	
Length	01h	
ciUnwantedUserStatus="unwantedUserIntuded"	00h	

Figure D.2 - Encoding of callIntrusionRequest result operation

D.4 callIntrusionGetCIPL invoke (ciGetCIPL.inv) operation

Figure D.3 shows the encoding of the callIntrusionGetCIPL (ciGetCIPL.inv) invoke operation.

STRUCTURE	CODING	REMARKS
Facility IE	1Ch	
Length of Facility IE	13h	
Protocol Profile="Network Extensions" (1Fh)	9Fh	
Network Facility Extension IE (10)	AAh	
Length of Network Facility Extension IE	06h	
Source Entity	80h	
Length	01h	
source entity = "endPINX" (0)	00h	
Destination Entity (2)	82h	
Length	01h	
destination entity = "endPINX" (0)	00h	
Invoke PDU [1]	A1h	
Length of invoke PDU	08h	
InvokeIDtype (integer)	02h	
Length	01h	
InvokeID	xxh	00h-FFh (NOTE in subclause C.1)
Operation (integer)	02h	
Length	01h	
0 operation Value="ci-getCIPL" (44)	2Ch	
Argument (null)	05h	
Length	00h	

Figure D.3 - Encoding of callIntrusionGetCIPL invoke operation

D.5 callIntrusionGetCIPL result (ciGetCIPL.res) operation

Figure D.4 shows the encoding of the callIntrusionGetCIPL result (ciGetCIPL.res) operation.

STRUCTURE	CODING	REMARKS
Facility IE	1Ch	
Length of Facility IE	18h	
Protocol Profile="Network Extensions" (1Fh)	9Fh	
Network Facility Extension IE (10)	AAh	
Length of Network Facility Extension IE	06h	
Source Entity	80h	
Length	01h	
source entity = "endPINX" (0)	00h	
Destination Entity (2)	82h	
Length	01h	
destination entity = "endPINX" (0)	00h	
ReturnResultPDU [2]	A2h	
Length of invoke PDU	0Dh	
InvokeIDtype (integer)	02h	
Length	01h	
InvokeID	xxh	00h-FFh (NOTE in subclause C.1)
Sequence	30h	
Length	08h	
Operation (integer)	02h	
Length	01h	
0 operation Value="ci-getCIPL" (44)	2Ch	
Result (sequence)	30h	
Length	03h	
CIProtectionLevel (enum)	0Ah	
Length	01h	
ciProtectionLevel	xxh	

Figure D.4 - Encoding of callIntrusionGetCIPL result operation

D.6 callIntrusionCompleted invoke (ciCompleted.inv) operation

Figure D.5 shows the encoding of the callIntrusionCompleted invoke (ciCompleted.inv) operation.

STRUCTURE	CODING	REMARKS
Facility IE	1Ch	
Length of Facility IE	16h	
Protocol Profile="Network Extensions" (1Fh)	9Fh	
Network Facility Extension IE (10)	AAh	
Length of Network Facility Extension IE	06h	
Source Entity	80h	
Length	01h	
source entity = "endPINX" (0)	00h	
Destination Entity (2)	82h	
Length	01h	
destination entity = "endPINX" (0)	00h	
InterpretationApu [1]	8Bh	
Length	01h	
discardAnyUnrecognised (0)	00h	
Invoke PDU [1]	A1h	
Length of invoke PDU	08h	
InvokeIDtype (integer)	02h	
Length	01h	
InvokeID	xxh	00h-FFh (NOTE in subclause C.1)
Operation (integer)	02h	
Length	01h	
0 operation Value="ci-complete" (48)	30h	
Argument (null)	05h	
Length	00h	

Figure D.5 - Encoding of callIntrusionCompleted invoke operation

D.7 Call intrusion notifications

Figure D.6 and table D.1 show the encoding of the call intrusion notifications.

STRUCTURE	CODING	REMARKS
Notification IE	27h	
Length of Facility IE	09h	
Notification Descriptor	C0h	
sequence	30h	
Length	06h	
Notification (integer)	02h	
Length	02h	
notificationValueHB	07h	
notificationValueLB	NV-LB	see table C.1 below
Argument (null)	05h	
Length	00h	

Figure D.6 - Encoding of call intrusion notifications

Table D.1 - Coding of least significant octet of SS-CI notification values

Supplementary Service Notifications	NV-LB
intrusionIsimpending (2003)	D3h
intrusionIsEffective (2004)	D4h
endOfIntrusion (2007)	D7h

D.8 Call intrusion errors

Figures D.7 - D.9 and tables D.2 - D.4 show the encoding of call intrusion errors.

STRUCTURE	CODING	REMARKS
Facility IE	1Ch	
Length of Facility IE	12h	
Protocol Profile="Network Extensions" (1Fh)	9Fh	
Network Facility Extension IE (10)	AAh	
Length of Network Facility Extension IE	06h	
Source Entity (0)	80h	
Length	01h	
source entity = "endPINX" (0)	00h	
Destination Entity (2)	82h	
Length	01h	
destination entity = "endPINX" (0)	00h	
ReturnErrorPDU (3)	A3h	
Length of ReturnErrorPDU	07h	
InvokeIDtype (integer)	02h	
Length	01h	
InvokeID	xxh	00h-FFh (NOTE in subclause C.1)
Error (integer)	02h	
Length	02h	
errorValueHB	03h	
errorValueLB	EV-LB	see table C.2 below

Figure D.7 - Encoding of call intrusion errors (1)

Table D.2 - Coding of least significant octet of the error values

Supplementary Service Errors	EV-LB
temporarilyUnavailable (1000)	E8h
notAuthorised (1007)	Efh
notBusy (1009)	F1h
Unspecified (1008)	F0h

STRUCTURE	CODING	REMARKS
Facility IE Length of Facility IE Protocol Profile="Network Extensions" (1Fh)	1Ch 11h 9Fh	
Network Facility Extension IE (10) Length of Network Facility Extension IE	AAh 06h	
Source Entity (0) Length	80h 01h	
[source entity = "endPINX" (0)]	00h	
Destination Entity (2) Length	82h 01h	
[destination entity = "endPINX" (0)]	00h	
ReturnErrorPDU (3) Length of ReturnErrorPDU	A3h 06h	
InvokeIDtype (integer) Length	02h 01h	
[InvokeID]	xxh	00h-FFh (NOTE in subclause C.1)
Error (integer) Length	02h 01h	
[errorValueHB]	EV	see table C.3 below

Figure D.8 - Encoding of call intrusion errors (2)

Table D.3 - Coding of the error values

Supplementary Service Errors	EV
notavailable (3)	03h
InteractionNotAllowed (100)	64h
NOTE A PINX conforming with this Standard should not generate either of the above errors; however, it should be able to act correctly if either error is received.	

STRUCTURE	CODING	REMARKS
Facility IE	1Ch	
Length of Facility IE	11h	
Protocol Profile="Network Extensions" (1Fh)	9Fh	
Network Facility Extension IE (10)	AAh	
Length of Network Facility Extension IE	06h	
Source Entity (0)	80h	
Length	01h	
source entity = "endPINX" (0)	00h	
Destination Entity (2)	82h	
Length	01h	
destination entity = "endPINX" (0)	00h	
RejectPDU (4)	A4h	
Length of RejectPDU	06h	
InvokeIDtype (integer)	02h	
Length	01h	
InvokeID	xxh	00h-FFh (NOTE in subclause C.1)
Problem type	PTV	see table C.4 below
Length	01h	
Problem	PV	see table C.4 below

Figure D.9 - Encoding of call intrusion reject PDU

Table D.4 - Coding of the error values

Problem Type	PTV	PV
General Problem [0] unrecognizedAPDU (0) mistypedAPDU (1) unrecognisedAPDU (2)	80h	00h 01h 02h
InvokeProblem1 DuplicatedInvocation (0) unrecognisedOperation (1) mistypedArgument (2) resourceLimitation (3) initiatorReleasing (4)	81h	00h 01h 02h 03h 04h
ReturnResultProblem [2] unrecognisedInvocation (0) resultResponseUnexpected (1) mistypedResult (2)	82h	00h 01h 02h
ReturnErrorProblem [3] unrecognisedInvocation (0) resultResponseUnexpected (1) unrecognisedError (2) unexpectedError (3)	83h	00h 01h 02h 03h
<p><i>NOTE</i> <i>A PINX conforming with this Standard should not generate either of the above errors; however, it should be able to act correctly if either error is received.</i></p>		

D.9 callInterruptionRequest invoke (cpiRequest.inv) operation

Figure D.10 shows the encoding of the callInterruptionRequest invoke (cpiRequest.inv) operation.

STRUCTURE	CODING	REMARKS
Facility IE	1Ch	
Length of Facility IE	19h	
Protocol Profile="Network Extensions" (1Fh)	9Fh	
Network Facility Extension IE (10)	AAh	
Length of Network Facility Extension IE	06h	
Source Entity (0)	80h	
Length	01h	
source entity = "endPINX"	00h	
Destination Entity (2)	82h	
Length	01h	
destination entity = "anytypeofPINX"	01h	
InterpretationAPDU	8Bh	
Length	01h	
InterpretationAPDU="discardAnyUnrecognised InvokePDU"	00h	
Invoke PDU [1]	A1h	
Length of invoke PDU	0Bh	
InvokeIDtype (integer)	02h	
Length	01h	
[InvokeID	xxh	00h-FFh (NOTE in subclause C.1)
Operation (integer)	02h	
Length	01h	
operationValue="cpi-request"	57h	
Argument (sequence)	30h	
Length	03h	
CPICapabilityLevel (enumerated)	0Ah	
Length	01h	
cpiCapabilityLevel	xxh	00h-03h

Figure D.10 - Encoding of callInterruptionRequest invoke operation

D.10 callProtectionRequest invoke (cpipRequest.inv) operation

Figure D.11 shows the encoding of the callProtectionRequest invoke (cpipRequest.inv) operation.

STRUCTURE	CODING	REMARKS
Facility IE	1Ch	
Length of Facility IE	19h	
Protocol Profile="Network Extensions" (1Fh)	9Fh	
Network Facility Extension IE (10)	AAh	
Length of Network Facility Extension IE	06h	
Source Entity (0)	80h	
Length	01h	
source entity = "endPINX"	00h	
Destination Entity (2)	82h	
Length	01h	
destination entity = "anytypeofPINX"	01h	
InterpretationAPDU	8Bh	
Length	01h	
InterpretationAPDU="discardAnyUnrecognised InvokePDU"	00h	
Invoke PDU [1]	A1h	
Length of invoke PDU	0Bh	
InvokeIDtype (integer)	02h	
Length	01h	
InvokeID	xxh	00h-FFh (NOTE in subclause C.1)
Operation (integer)	02h	
Length	01h	
operationValue="cpi-request"	58h	
Argument (sequence)	30h	
Length	03h	
CPIProtectionLevel (enumerated)	0Ah	
Length	01h	
cpiProtectionLevel	xxh	00h-03h

Figure D.11 - Encoding of callProtectionRequest invoke operation

D.11 Call priority interruption notifications

Figure D.12 and table D.5 show the encoding of call priority interruption notifications.

STRUCTURE	CODING	REMARKS
Notification IE	27h	
Length of Facility IE	09h	
Notification Descriptor	C0h	
sequence	30h	
Length	06h	
Notification (integer)	02h	
Length	02h	
notificationValueHB	07h	
notificationValueLB	NV-LB	see table C.5 below
Argument (null)	05h	
Length	00h	

Figure D.12 - Encoding of call priority interruption notifications

Table D.5 - Coding of least significant octet of SS-CPI notification values

Call Priority Interruption (QSIG-CPI)	NV-LB
interruptionIsImpending (2008)	D8h
interruptionTerminated (2009)	D9h
interruptionForcedRelease (2010)	DAh

Free printed copies can be ordered from:

ECMA

114 Rue du Rhône

CH-1204 Geneva

Switzerland

Fax: +41 22 849.60.01

Email: documents@ecma.ch

Files of this Standard can be freely downloaded from the ECMA web site (www.ecma.ch). This site gives full information on ECMA, ECMA activities, ECMA Standards and Technical Reports.

ECMA
114 Rue du Rhône
CH-1204 Geneva
Switzerland

See inside cover page for obtaining further soft or hard copies.